



The Secretary
of the Interior's
Standards for
Rehabilitation &

Illustrated
Guidelines
for
Rehabilitating
Historic
Buildings



U.S. Department of the Interior
National Park Service
Cultural Resources
Heritage Preservation Services

The Secretary of the Interior's Standards for Historic Preservation Projects with Guidelines for Applying the Standards were written in 1976 by W. Brown Morton III and Gary L. Hume (the ten Standards for Rehabilitation and their guidelines have been the most-used component of this larger document which also contains standards and guidelines for acquisition, protection, stabilization, preservation, restoration, and reconstruction). The guidelines to the rehabilitation standards were revised and expanded in 1983 by Gary L. Hume and Kay D. Weeks and issued together with the 1976 standards as a separate book entitled *The Secretary of the Interior's Standards for Rehabilitation with Guidelines for Applying the Standards*. The 1976 Standards for Rehabilitation were revised in 1990 by Gary L. Hume, H. Ward Jandl, and Kay D. Weeks following a public commenting period.

The Secretary of the Interior's Standard's for Rehabilitation and Illustrated Guidelines for Rehabilitating Historic Buildings / W. Brown Morton III ... [et al.] ; Anne E. Grimmer and Kay D. Weeks, project directors.

p. cm.

Includes bibliographical references.

1. Architecture—United States—Conservation and restoration—Standards. 2. Historic buildings—United States—Conservation and restoration—Standards. I. Morton, W. Brown. II. Grimmer, Anne E.. III. Weeks, Kay D. IV. United States. National Park Service. Preservation Assistance Division. V. Title: Illustrated guidelines for rehabilitating historic buildings.

NA106.S4 1991

720'.28'8021873—dc20

91-27060

CIP

The Secretary of the Interior's
Standards for Rehabilitation &
*Illustrated Guidelines for
Rehabilitating Historic Buildings*

W. BROWN MORTON III • GARY L. HUME • KAY D. WEEKS • H. WARD JANDL

ANNE E. GRIMMER AND KAY D. WEEKS

Project Directors

U.S. Department of the Interior
National Park Service
Heritage Preservation Services

Washington, D.C.
Reprinted 1997

Contents



Acknowledgements	iii	Building Interior <i>Structural Systems</i>	47
Foreword	iv	Building Interior <i>Spaces, Features, and Finishes</i>	53
The Secretary of the Interior's Standards for Rehabilitation	v	Building Interior <i>Mechanical Systems</i>	61
Guidelines for Rehabilitating Historic Buildings	viii	Building Site	67
Building Exterior <i>Masonry</i>	1	Setting <i>District or Neighborhood</i>	75
Building Exterior <i>Wood</i>	9	Energy Conservation	83
Building Exterior <i>Architectural Metals</i>	17	New Additions to Historic Buildings	89
Building Exterior <i>Roofs</i>	23	Accessibility Considerations	95
Building Exterior <i>Windows</i>	29	Health and Safety Considerations	99
Building Exterior <i>Entrances and Porches</i>	35	<i>Appendix</i>	
Building Exterior <i>Storefronts</i>	41	Technical Guidance Publications	105

Photo Credit for Book Cover

Front/Back Covers: Residential rehabilitation, Seattle, Washington. © 1991. Mary Randlett.

Photo Credits for Chapter Heads

Building Exterior—Masonry. Jack E. Boucher, HABS.

Building Exterior—Wood. Jack E. Boucher, HABS.

Building Exterior—Architectural Metals.
Cervin Robinson, HABS.

Building Exterior—Roofs. Jack E. Boucher, HABS.

Building Exterior—Windows. Jack E. Boucher, HABS.

Building Exterior—Entrances and Porches.
Jack E. Boucher, HABS.

Building Exterior—Storefronts. Jack E. Boucher, HABS.

Building Interior—Structural Systems.
Cervin Robinson, HABS.

Building Interior—Spaces, Features and Finishes.
Brooks Photographers, HABS Collection.

Building Interior—Mechanical Systems.
National Park Service Files.

Building Site. Jack E. Boucher, HABS.

Setting (District or Neighborhood). Charles Ashton.

Energy Conservation. Laura A. Muckenfuss.

New Additions to Historic Buildings. Rodney Gary.

Accessibility Considerations. Department of Cultural
Resources, Raleigh, North Carolina.

Health and Safety Considerations.
National Park Service Files.



Acknowledgements

The illustrated version of the Standards and Guidelines for Rehabilitation was developed by the Technical Preservation Services Branch, Preservation Assistance Division of the National Park Service. Project Directors Anne E. Grimmer and Kay D. Weeks wish to thank those professional staff members who assisted in the book's preparation by providing technical review of the text, conducting photo research, and taking photographs. They include Michael J. Auer, Charles E. Fisher, Thomas C. Jester, Lauren G. Meier, ASLA, and Sharon C. Park, AIA. Tim Buehner prepared several technical drawings. Special thanks go to Jack E. Boucher and Catherine LaVoie of the Historic American Buildings Survey (HABS) who were especially helpful in conducting photographic research. Boucher's work appears throughout the book. Mary Randlett's photograph of ongoing rehabilitation work is featured on the cover.

All photographs and drawings included in this publication not individually credited have been selected from National Park Service Files.



HABS Collection

Foreword

A banner year, 1991 marks the 75th anniversary of the National Park Service as well as 25 years of preservation achievements resulting from passage of the National Historic Preservation Act of 1966. Publication of the *illustrated* Guidelines for Rehabilitating Historic Buildings fittingly coincides with the celebration of this important Act that created our National Register programs and established a solid Federal/State partnership nationwide. Since 1966, over 800,000 properties have been placed in the National Register of Historic Places through the joint efforts of State Historic Preservation Offices, Federal agencies, Certified Local Governments, and the private sector. Over the past quarter century, historic preservation grants to the States for survey, planning and rehabilitation have amounted to nearly \$600 million, an investment totaling close to \$1.2 billion with the inclusion of matching non-Federal funds. Additionally, the Preservation Tax Incentives, now in their 14th year, have contributed to the rehabilitation of nearly 22,000 historic properties, representing an investment of almost \$15 billion in private funds.

appropriateness of work treatments for every grant-in-aid and Tax Act project over a 25-year period. By emphasizing repair over replacement, and limited rather than wholesale change to accommodate new uses, the Standards and their accompanying Guidelines seek to ensure the preservation of those qualities for which each property was listed in the National Register.

Finally, this illustrated version of the Guidelines for Rehabilitating Historic Buildings has been designed to enhance overall understanding of basic preservation principles. Showing specific examples of appropriate treatments as well as the consequences of inappropriate treatments is just another aspect of a sustained effort to encourage the most respectful approaches possible in rehabilitating our nation's irreplaceable historic properties.

The Secretary of the Interior's Standards are of particular relevance here because they have been used to determine the

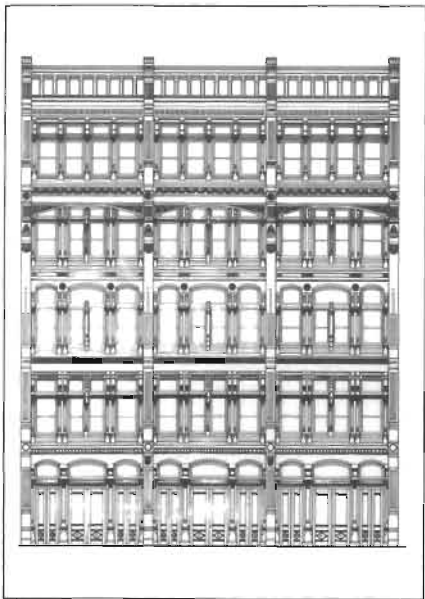

HABS Collection

*The Secretary of the Interior's
Standards for Rehabilitation*

Introduction to the Standards

The Secretary of the Interior is responsible for establishing standards for all programs under Departmental authority and for advising Federal agencies on the preservation of historic properties listed in or eligible for listing in the National Register of Historic Places. In partial fulfillment of this responsibility, the Secretary of the Interior's Standards for Historic Preservation Projects have been developed to guide work undertaken on historic buildings; there are separate standards for acquisition, protection, stabilization, preservation, rehabilitation, restoration, and reconstruction. **The Standards for Rehabilitation** (codified in 36 CFR 67) comprise that section of the overall preservation project standards and addresses the most prevalent treatment. "Rehabilitation" is defined as "the process of returning a property to a state of utility, through repair or alteration, which makes possible an efficient contemporary use while preserving those portions and features of the property which are significant to its historic, architectural, and cultural values."

Initially developed by the Secretary of the Interior to determine the appropriateness of proposed project work on registered properties within the Historic Preservation Fund grant-in-aid program, the **Standards for Rehabilitation** have been widely used

over the years — particularly to determine if a rehabilitation qualifies as a Certified Rehabilitation for Federal purposes. In addition, the Standards have guided



Federal agencies in carrying out their historic preservation responsibilities for properties in Federal ownership or control; and State and local officials in reviewing

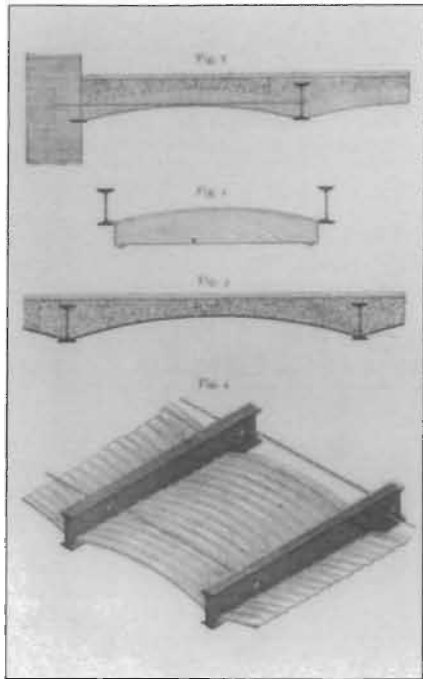

both Federal and nonfederal rehabilitation proposals. They have also been adopted by historic district and planning commissions across the country.

The intent of the Standards is to assist the long-term preservation of a property's significance through the preservation of historic materials and features. The Standards pertain to historic buildings of all materials, construction types, sizes, and occupancy and encompass the exterior and interior of the buildings. They also encompass related landscape features and the building's site and environment, as well as attached, adjacent, or related new construction. To be certified for Federal tax purposes, a rehabilitation project must be determined by the Secretary to be consistent with the historic character of the structure(s), and where applicable, the district in which it is located.

As stated in the definition, the treatment "rehabilitation" assumes that at least some repair or alteration of the historic building will be needed in order to provide for an efficient contemporary use; however, these repairs and alterations must not damage or destroy materials, features or finishes that are important in defining the building's historic character. For example, certain treatments —if improperly applied—may cause or accelerate physical deterioration

of the historic building. This can include using improper repointing or exterior masonry cleaning techniques, or introducing insulation that damages historic fabric. In almost all of these situations, use of these materials and treatments will result in a project that does not meet the Standards. Similarly, exterior additions that duplicate the form, material, and detailing of the structure to the extent that they compromise the historic character of the structure will fail to meet the Standards.

The Secretary of the Interior's Standards for Rehabilitation

The Standards (Department of Interior regulations, 36 CFR 67) pertain to historic buildings of all materials, construction types, sizes, and occupancy and encompass the exterior and the interior, related landscape features and the building's site and environment as well as attached, adjacent, or related new construction. The Standards are to be applied to specific rehabilitation projects in a reasonable manner, taking into consideration economic and technical feasibility.

1. A property shall be used for its historic purpose or be placed in a new use that requires minimal change to the defining characteristics of the building and its site and environment.

2. The historic character of a property shall be retained and preserved. The removal of historic materials or alteration of features and spaces that characterize a property shall be avoided.

3. Each property shall be recognized as a physical record of its time, place, and use. Changes that create a false sense of historical development, such as adding conjectural features or architectural elements from other buildings, shall not be undertaken.

4. Most properties change over time; those changes that have acquired historic significance in their own right shall be retained and preserved.

5. Distinctive features, finishes, and construction techniques or examples of craftsmanship that characterize a property shall be preserved.

6. Deteriorated historic features shall be repaired rather than replaced. Where the severity of deterioration requires replacement of a distinctive feature, the new feature shall match the old in design, color, texture, and other visual qualities and, where possible, materials. Replacement of missing features shall be substantiated by documentary, physical, or pictorial evidence.

7. Chemical or physical treatments, such as sandblasting, that cause damage to historic materials shall not be used. The surface cleaning of structures, if appropriate, shall be undertaken using the gentlest means possible.

8. Significant archeological resources affected by a project shall be protected and preserved. If such resources must be disturbed, mitigation measures shall be undertaken.

9. New additions, exterior alterations, or related new construction shall not destroy historic materials that characterize the property. The new work shall be differentiated from the old and shall be compatible with the massing, size, scale, and architectural features to protect the historic integrity of the property and its environment.

10. New additions and adjacent or related new construction shall be undertaken in such a manner that if removed in the future, the essential form and integrity of the historic property and its environment would be unimpaired.



Guidelines for Rehabilitating Historic Buildings

Introduction to the Guidelines

The Guidelines for Rehabilitating Historic Buildings were initially developed in 1977 to help property owners, developers, and Federal managers apply the Secretary of the Interior's "Standards for Rehabilitation" during the project planning stage by providing general design and technical recommendations. Unlike the Standards, the Guidelines are *not* codified as program

cannot tell owners or developers which features of their own historic building are important in defining the historic character and must be preserved—although examples are provided in each section—or which features could be altered, if necessary, for the new use. This kind of careful case-by-case decision-making is best accomplished by seeking assistance from qualified historic preservation professionals in the planning stage of the project. Such professionals include architects, architectural historians, historians, archeologists, and others who are skilled in the preservation, rehabilitation, and restoration of the historic properties.

The Guidelines pertain to historic buildings of all sizes, materials, occupancy, and construction types; and apply to interior and exterior work as well as new exterior additions. Those approaches, treatments, and techniques that are consistent with the Secretary of the Interior's "Standards for Rehabilitation" are listed in the "**Recommended**" column on the left; those approaches, treatments, and techniques which could adversely affect a building's historic character are listed in the "**Not Recommended**" column on the right.



Drawing: Nicholas Sazzerlee

requirements. Together with the "Standards for Rehabilitation," they provide a model process for owners, developers, and Federal agency managers to follow.

The Guidelines are intended to assist in applying the Standards to projects generally; consequently, they are not meant to give case-specific advice or address exceptions or rare instances. For example, they

To provide clear and consistent guidance for owners, developers, and Federal agency managers to follow, the “Recommended” courses of action in each section are listed in order of historic preservation concerns so that a rehabilitation project may be successfully planned and completed—one that, first, assures the preservation of a building’s important or “character-defining” architectural materials and features and, second, makes possible an efficient contemporary use. Rehabilitation guidance in each section begins with protection and maintenance, that work which should be maximized in every project to enhance overall preservation goals. Next, where some deterioration is present, repair of the building’s historic materials and features is recommended. Finally, when deterioration is so extensive that repair is not possible, the most problematic area of work is considered: replacement of historic materials and features with new materials.

To further guide the owner and developer in planning a successful rehabilitation project, those complex design issues dealing with new use requirements such as alterations and additions are highlighted at the end of each section to underscore the need for particular sensitivity in these areas.

Identify, Retain, and Preserve

The guidance that is basic to the treatment of all historic buildings—*identifying, retaining, and preserving* the form and detailing of those architectural materials and features that are important in *defining the historic character*—is always listed first in the “Recommended” column. The parallel “Not Recommended” column lists the types of actions that are most apt to cause the diminution or even loss of the building’s historic character. It should be remembered, however, that such loss of character is just as often caused by the cumulative effect of a series of actions that would seem to be minor interventions. Thus, the guidance in *all* of the “Not Recommended” columns must be viewed in that larger context, e.g., for the total impact on a historic building.

Protect and Maintain

After identifying those materials and features that are important and must be retained in the process of rehabilitation work, then *protecting and maintaining* them are addressed. Protection generally involves the least degree of intervention and is preparatory to other work. For example, protection includes the maintenance of historic material through treat-

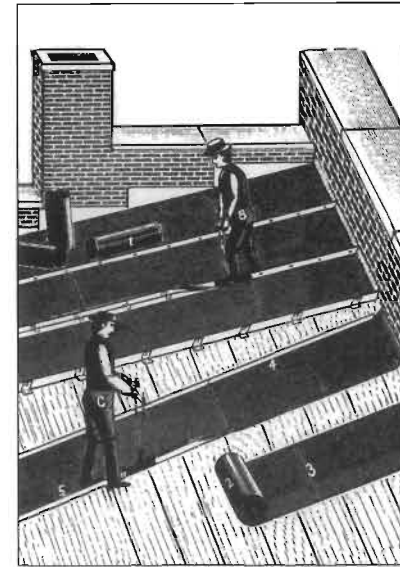

ments such as rust removal, caulking, limited paint removal, and re-application of protective coating; the cyclical cleaning of roof gutter systems; or installation of fencing, protective plywood, alarm systems and other temporary protective measures. Although a historic building will usually require more extensive work, an overall evaluation of its physical condition should always begin at this level.

Repair

Next, when the physical condition of character-defining materials and features warrants additional work *repairing* is recommended. Guidance for the repair of historic materials such as masonry, wood, and architectural metals again begins with the least degree of intervention possible such as patching, piecing-in, splicing, consolidating, or otherwise reinforcing or upgrading them according to recognized preservation methods. Repairing also includes the limited replacement in kind—or with compatible substitute material—of extensively deteriorated or missing *parts* of features when there are surviving prototypes (for example, brackets, dentils, steps, plaster, or portions of slate or tile roofing). Although using the same kind of material is always the preferred option, substitute material is acceptable if the form and design as well as the substitute material

itself convey the visual appearance of the remaining parts of the feature and finish.

Replace

Following repair in the hierarchy, guidance is provided for *replacing* an entire

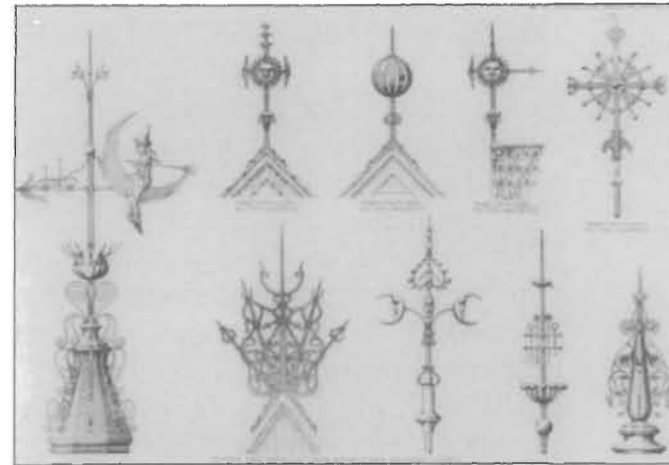

character-defining feature with new material because the level of deterioration or damage of materials precludes repair (for example, an exterior cornice; an interior staircase; or a complete porch or storefront). If the essential form and detailing are still evident so that the physical evidence can be used to re-establish the feature as an integral part of the rehabilitation project, then its replacement is appropriate. Like the guidance for repair, the preferred option is always replacement of the entire feature in kind, that is, with the

same material. Because this approach may not always be technically or economically feasible, provisions are made to consider the use of a compatible substitute material.

It should be noted that, while the National Park Service guidelines recommend the replacement of an entire character-defining feature under certain well-defined circumstances, they *never* recommend removal and replacement with new material of a feature that—although damaged or deteriorated—could reasonably be repaired and thus preserved.

Design for Missing Historic Features

When an entire interior or exterior feature is missing (for example, an entrance, or cast iron facade; or a principal staircase), it no longer plays a role in physically defining the historic character of the building unless it can be accurately recovered in form and detailing through the process of carefully documenting the historical appearance. Where an important architectural feature is missing, its recovery is always recommended in the guidelines as the *first* or preferred, course of action. Thus, if adequate historical, pictorial, and physical documentation exists so that the feature may be accurately reproduced, and if it is desirable to re-establish the feature as part of the building's historical appearance, then designing and constructing a

new feature based on such information is appropriate. However, a *second* acceptable option for the replacement feature is a



new design that is compatible with the remaining character-defining features of the historic building. The new design should always take into account the size, scale, and material of the historic building itself and, most importantly, should be clearly differentiated so that a false historical appearance is not created.

Alterations/Additions to Historic Buildings

Some exterior and interior alterations to historic building are generally needed to assure its continued use, but it is most important that such alterations do not radically change, obscure, or destroy character-defining spaces, materials, features, or finishes. Alterations may include providing additional parking space on an existing historic building site; cutting new entrances or windows on secondary elevations; inserting an additional floor; installing an entirely new mechanical system; or creating an atrium or light well. Alteration may also include the selective removal of buildings or other features of the environment or building site that are intrusive and therefore detract from the overall historic character.

The construction of an exterior addition to a historic building may seem to be essential for the new use, but it is emphasized in the guidelines that such new additions should be avoided, if possible, and considered *only* after it is determined that those needs cannot be met by altering secondary, i.e., non character-defining interior spaces. If, after a thorough evaluation of interior solutions, an exterior addition is still judged to be the only viable alternative, it should be designed and constructed to be clearly differentiated from the historic

building and so that the character-defining features are not radically changed, obscured, damaged, or destroyed.

Additions to historic buildings are referenced within specific sections of the guidelines such as Site, Roof, Structural Systems, etc., but are also considered in more detail in a separate section, *New Additions to Historic Buildings*.

Energy Conservation/Accessibility Considerations/Health and Safety Code Considerations

These sections of the rehabilitation guidance address work done to meet accessibility requirements and health and safety code requirements; or retrofitting measures to conserve energy. Although this work is quite often an important aspect of rehabilitation projects, it is usually not a part of the overall process of protecting or repairing character-defining features; rather, such work is assessed for its potential negative impact on the building's historic character. For this reason, particular care must be taken not to radically change, obscure, damage, or destroy character-defining materials or features in the process of undertaking work to meet various code requirements.



Building Exterior

Masonry

BRICK

STONE

TERRA COTTA

CONCRETE

ADOBE

STUCCO

MORTAR

Building Exterior

Masonry

The longevity and appearance of a masonry wall is dependent upon the size of the individual units and the mortar.

Stone is one of the more lasting of masonry building materials and has been used throughout the history of American building construction. The kinds of stone most commonly encountered on historic buildings in the U.S. include various types of sandstone, limestone, marble, granite, slate and fieldstone. Brick varied considerably in size and quality. Before 1870, brick clays were pressed into molds and were often unevenly fired. The quality of brick depended on the type of clay available and the brick-making techniques; by the 1870s—with the perfection of an extrusion process—bricks became more uniform and durable. Terra cotta is also a kiln-dried clay product popular from the late 19th century until the 1930s. The development of the steel-frame office buildings in the early 20th century contributed to the widespread use of architectural terra cotta. Adobe, which consists of sun-dried earthen bricks, was one of the earliest permanent building materials used in the U.S., primarily in the Southwest where it is still popular.

Mortar is used to bond together masonry units. Historic mortar was generally quite soft, consisting primarily of lime and sand with other additives. After 1880, portland cement was usually added resulting in a more rigid and non-absorbing mortar. Like historic mortar, early stucco coatings were also heavily lime-based, increasing in hardness with the addition of portland cement in the late 19th century. Concrete has a long history, being variously made of tabby, volcanic ash and, later, of natural hydraulic cements, before the introduction of portland cement in the 1870s. Since then, concrete has also been used in its precast form.

While masonry is among the most durable of historic building materials, it is also very susceptible to damage by improper maintenance or repair techniques and harsh or abrasive cleaning methods.



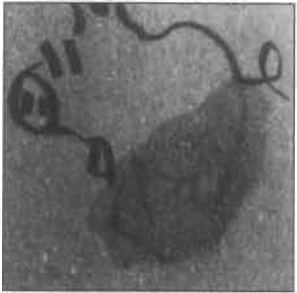
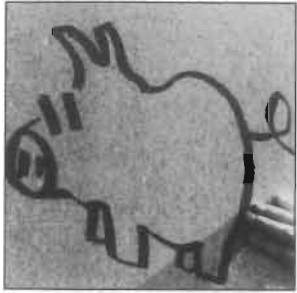

Graffiti applied with a felt-tipped marker to polished granite is being removed with a mixture of solvents. The slight ghost outline was successfully eliminated using the same solvent mixture in a clay poultice, followed by a thorough detergent and water rinse.

Recommended

Identify, retain, and preserve

Identifying, retaining, and preserving masonry features that are important in defining the overall historic character of the building such as walls, brackets, railings, cornices, window architraves, door pediments, steps, and columns and details such as tooling and bonding patterns, coatings, and color.

Protect and maintain

Protecting and maintaining masonry by providing proper drainage so that water does not stand on flat, horizontal surfaces or accumulate in curved decorative features.

Cleaning masonry only when necessary to halt deterioration or remove heavy soiling.

Carrying out masonry surface cleaning tests after it has been determined that such cleaning is appropriate. Tests should be observed over a sufficient period of time so that both the immediate and the long range effects are known to enable selection of the gentlest method possible.

Not Recommended

Removing or radically changing masonry features which are important in defining the overall historic character of the building so that, as a result, the character is diminished.

Replacing or rebuilding a major portion of exterior masonry walls that could be repaired so that, as a result, the building is no longer historic and is essentially new construction.

Applying paint or other coatings such as stucco to masonry that has been historically unpainted or uncoated to create a new appearance.

Removing paint from historically painted masonry.

Radically changing the type of paint or coating or its color.

Failing to evaluate and treat the various causes of mortar joint deterioration such as leaking roofs or gutters, differential settlement of the building, capillary action, or extreme weather exposure.

Cleaning masonry surfaces when they are not heavily soiled to create a new appearance, thus needlessly introducing chemicals or moisture into historic materials.

Cleaning masonry surfaces without testing or without sufficient time for the testing results to be of value.

Recommended

Cleaning masonry surfaces with the gentlest method possible, such as low pressure water and detergents, using natural bristle brushes.



Photo: Jack E. Boucher, HAAS

Too hard and inflexible a mortar has caused this soft, 18th century brick to spall.

Inspecting painted masonry surfaces to determine whether repainting is necessary.

Removing damaged or deteriorated paint only to the next sound layer using the gentlest method possible (e.g., handscraping) prior to repainting.

Applying compatible paint coating systems following proper surface preparation.

Repainting with colors that are historically appropriate to the building and district.

Not Recommended

Sandblasting brick or stone surfaces using dry or wet grit or other abrasives. These methods of cleaning permanently erode the surface of the material and accelerate deterioration.

Using a cleaning method that involves water or liquid chemical solutions when there is any possibility of freezing temperatures.

Cleaning with chemical products that will damage masonry, such as using acid on limestone or marble, or leaving chemicals on masonry surfaces.

Applying high pressure water cleaning methods that will damage historic masonry and the mortar joints.

Removing paint that is firmly adhering to, and thus protecting, masonry surfaces.

Using methods of removing paint which are destructive to masonry, such as sandblasting, application of caustic solutions, or high pressure waterblasting.

Failing to follow manufacturers' product and application instructions when repainting masonry.

Using new paint colors that are inappropriate to the historic building and district.

When this brick wall was sandblasted, a downspout (since removed) protected the original smooth surface of the center strip from damage.



Photo: The Old-House Journal

Recommended

Evaluating the overall condition of the masonry to determine whether more than protection and maintenance are required, that is, if repairs to the masonry features will be necessary.

Repair

Repairing masonry walls and other masonry features by repointing the mortar joints where there is evidence of deterioration such as disintegrating mortar, cracks in mortar joints, loose bricks, damp walls, or damaged plasterwork.

Not Recommended

Failing to undertake adequate measures to assure the protection of masonry features.

Removing nondeteriorated mortar from sound joints, then repointing the entire building to achieve a uniform appearance.



Composite patching with a cementitious mixture is being used to repair eroded areas of this sandstone facade.



Excessive moisture has damaged not only the stuccoed wall surface, but also the brick substrate.

Moisture from a faulty roof and drainage system has been trapped inside this limestone cornice by a waterproof coating, causing severe damage to the stone.

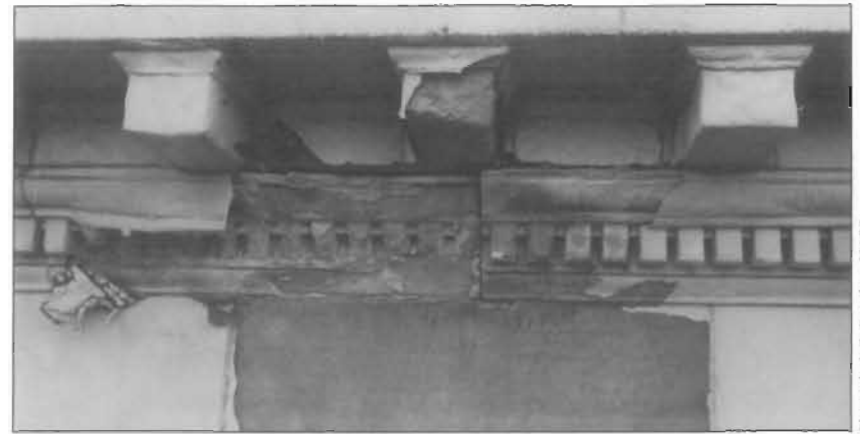

Recommended

Removing deteriorated mortar by carefully hand-raking the joints to avoid damaging the masonry.

Duplicating old mortar in strength, composition, color, and texture.

Duplicating old mortar joints in width and in joint profile.

Repairing stucco by removing the damaged material and patching with new stucco that duplicates the old in strength, composition, color, and texture.

Using mud plaster as a surface coating over unfired, unstabilized adobe because the mud plaster will bond to the adobe.

Not Recommended

Using electric saws and hammers rather than hand tools to remove deteriorated mortar from joints prior to repointing.

Repointing with mortar of high portland cement content (unless it is the content of the historic mortar). This can often create a bond that is stronger than the historic material and can cause damage as a result of the differing coefficient of expansion and the differing porosity of the material and the mortar.

Repointing with a synthetic caulking compound.

Using a “scrub” coating technique to repoint instead of traditional repointing methods.

Changing the width or joint profile when repointing.

Removing sound stucco; or repairing with new stucco that is stronger than the historic material or does not convey the same visual appearance.

Applying cement stucco to unfired, unstabilized adobe. Because the cement stucco will not bond properly, moisture can become entrapped between materials, resulting in accelerated deterioration of the adobe.

Recommended

Cutting damaged concrete back to remove the source of deterioration (often corrosion on metal reinforcement bars). The new patch must be applied carefully so it will bond satisfactorily with, and match, the historic concrete.

Repairing masonry features by patching, piecing-in, or consolidating the masonry using recognized preservation methods. Repair may also include the limited replacement in kind—or with compatible substitute material—of those extensively deteriorated or missing parts of masonry features when there are surviving prototypes such as terra-cotta brackets or stone balusters.

Applying new or non-historic surface treatments such as water-repellent coatings to masonry only after repointing and only if masonry repairs have failed to arrest water penetration problems.

Not Recommended

Patching concrete without removing the source of deterioration.

Replacing an entire masonry feature such as a cornice or balustrade when repair of the masonry and limited replacement of deteriorated or missing parts are appropriate.

Using a substitute material for the replacement part that does not convey the visual appearance of the surviving parts of the masonry feature or that is physically or chemically incompatible.

Applying waterproof, water repellent, or non-historic coating such as stucco to masonry as a substitute for repointing and masonry repairs. Coatings are frequently unnecessary, expensive, and may change the appearance of historic masonry as well as accelerate its deterioration.

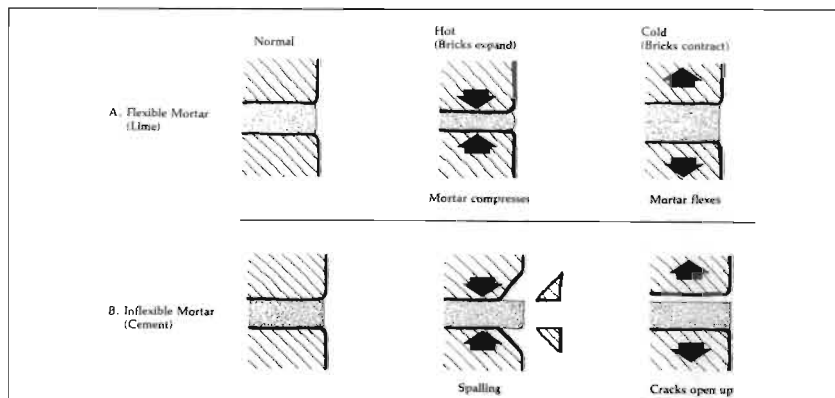

Flexible mortar expands and contracts with temperature changes. Bricks bonded by inflexible mortar tend to spall at the edges in hot weather and separate from the mortar when it is cold. Temperature fluctuations result in cracks which permit water to enter, causing additional deterioration.

Recommended

Replace

Replacing in kind an entire masonry feature that is too deteriorated to repair—if the overall form and detailing are still evident—using the physical evidence as a model to reproduce the feature. Examples can include large sections of a wall, a cornice, balustrade, column, or stairway. If using the same kind of material is not technically or economically feasible, then a compatible substitute material may be considered.



Not Recommended

Removing a masonry feature that is unrepairable and not replacing it; or replacing it with a new feature that does not convey the same visual appearance.

Design for Missing Historic Features

The following work is highlighted to indicate that it represents the particularly complex technical or design aspects of rehabilitation projects and should only be considered after the preservation concerns listed above have been addressed.

Recommended

Designing and installing a new masonry feature such as steps or a door pediment when the historic feature is completely missing. It may be an accurate restoration using historical, pictorial, and physical documentation; or be a new design that is compatible with the size, scale, material, and color of the historic building.

Not Recommended

Creating a false historical appearance because the replaced masonry feature is based on insufficient historical, pictorial, and physical documentation.

Introducing a new masonry feature that is incompatible in size, scale, material and color.

Coving—the hollowing out of an adobe wall just above grade—may be caused by standing rainwater, rainwater splash-up from the ground, or by salts deposited in the adobe by moisture evaporation. This adobe wall is being patched in the traditional manner with adobe mud.



Building Exterior

Wood

CLAPBOARD
WEATHERBOARD
SHINGLES AND
OTHER WOODEN SIDING
AND DECORATIVE ELEMENTS

Building Exterior

Wood

Because it can be easily shaped by sawing, planing, carving, and gouging, wood is used for architectural features such as clapboard, cornices, brackets, entablatures, shutters, columns and balustrades. These wooden features, both functional and decorative, may be important in defining the historic character of the building and thus their retention, protection, and repair are important in rehabilitation projects.

Wood has played a central role in American buildings during every period and in every style. Whether as structural membering, exterior cladding, roofing, interior finishes, or decorative features, wood is frequently an essential component of historic and older buildings.

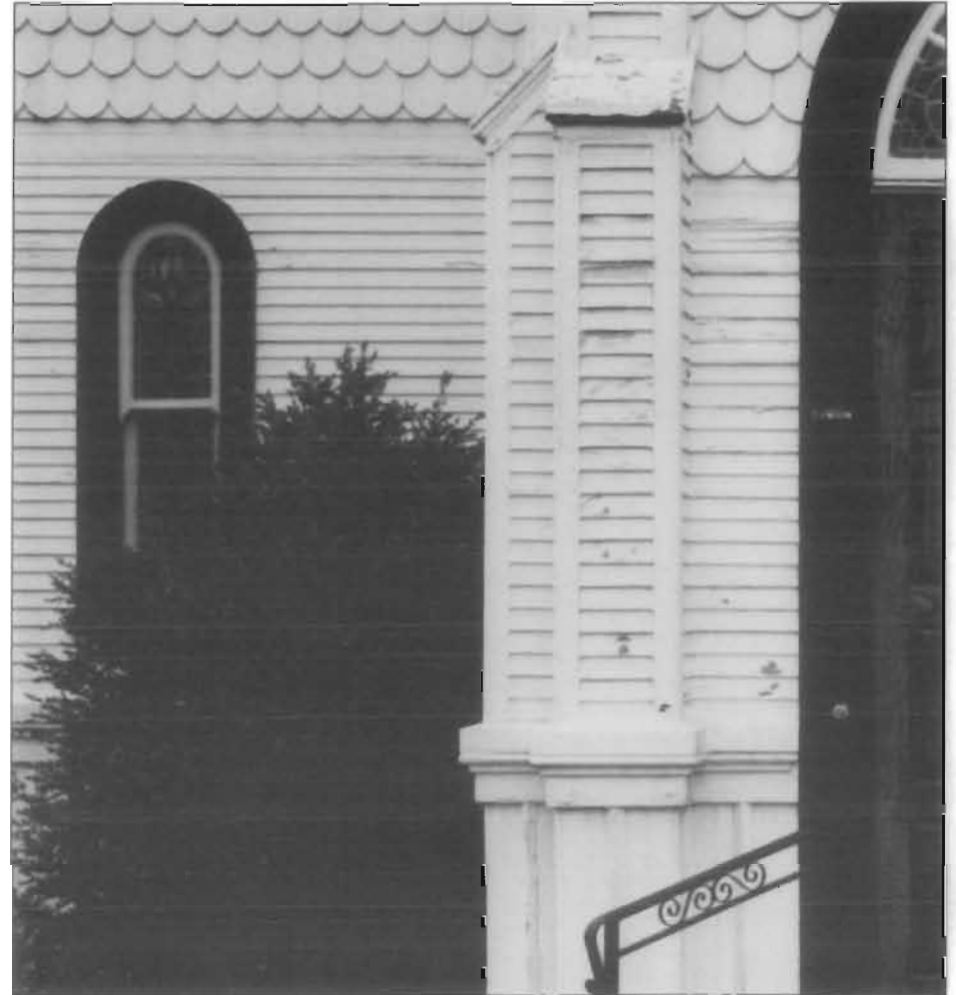

Recommended

Identify, retain, and preserve

Identifying, retaining, and preserving wood features that are important in defining the overall historic character of the building such as siding, cornices, brackets, window architraves, and doorway pediments; and their paints, finishes, and colors.

Due to lack of maintenance, the paint has peeled to bare wood. In order to survive, this cornice will need to be scraped, sanded, and re-painted together with other essential repairs.



Protect and maintain

Protecting and maintaining wood features by providing proper drainage so that water is not allowed to stand on flat, horizontal surfaces or accumulate in decorative features.

Applying chemical preservatives to wood features such as beam ends or outriggers that are exposed to decay hazards and are traditionally unpainted.

Not Recommended

Removing or radically changing wood features which are important in defining the overall historic character of the building so that, as a result, the character is diminished.

Removing a major portion of the historic wood from a facade instead of repairing or replacing only the deteriorated wood, then reconstructing the facade with new material in order to achieve a uniform or “improved” appearance.

Radically changing the type of finish or its color or accent scheme so that the historic character of the exterior is diminished.

Stripping historically painted surfaces to bare wood, then applying clear finishes or stains in order to create a “natural look.”

Stripping paint or varnish to bare wood rather than repairing or reapplying a special finish, i.e., a grained finish to an exterior wood feature such as a front door.

Failing to identify, evaluate, and treat the causes of wood deterioration, including faulty flashing, leaking gutters, cracks and holes in siding, deteriorated caulking in joints and seams, plant material growing too close to wood surfaces, or insect or fungus infestation.

Using chemical preservatives such as creosote which can change the appearance of wood features unless they were used historically.

Recommended

Retaining coatings such as paint that help protect the wood from moisture and ultraviolet light. Paint removal should be considered only where there is paint surface deterioration and as part of an overall maintenance program which involves repainting or applying other appropriate protective coatings.

Inspecting painted wood surfaces to determine whether repainting is necessary or if cleaning is all that is required.

If a character-defining feature is missing, it should be replaced with a matching feature. This shop artisan used traditional tools to replicate a missing porch bracket; after the new bracket is painted, both original and duplicate will be installed on-site.



Removing damaged or deteriorated paint to the next sound layer using the gentlest method possible (handscraping and handsanding), then repainting.

Not Recommended

Stripping paint or other coatings to reveal bare wood, thus exposing historically coated surfaces to the effects of accelerated weathering.

Removing paint that is firmly adhering to, and thus, protecting wood surfaces.

Replacing an entire wood feature such as a cornice or wall when repair of the wood and limited replacement of deteriorated or missing parts are appropriate.

Using substitute material for the replacement part that does not convey the visual appearance of the surviving parts of the wood feature or that is physically or chemically incompatible.

Using destructive paint removal methods such as a propane or butane torches, sandblasting or waterblasting. These methods can irreversibly damage historic woodwork.

Deteriorated clapboards are being selectively replaced, thereby maximizing retention of the historic siding.



Recommended

Using with care electric hot-air guns on decorative wood features and electric heat plates on flat wood surfaces when paint is so deteriorated that total removal is necessary prior to repainting.

Using chemical strippers primarily to supplement other methods such as handscraping, handsanding and the above-recommended thermal devices. Detachable wooden elements such as shutters, doors, and columns may—with the proper safeguards—be chemically dip-stripped.

Applying compatible paint coating systems following proper surface preparation.

Not Recommended

Using thermal devices improperly so that the historic woodwork is scorched.

Failing to neutralize the wood thoroughly after using chemicals so that new paint does not adhere.

Allowing detachable wood features to soak too long in a caustic solution so that the wood grain is raised and the surface roughened.

Failing to follow manufacturers' product and application instructions when repainting exterior woodwork.

Recommended

Repainting with colors that are appropriate to the historic building and district.

Evaluating the overall condition of the wood to determine whether more than protection and maintenance are required, that is, if repairs to wood features will be necessary.

Repair

Repairing wood features by patching, piecing-in, consolidating, or otherwise reinforcing the wood using recognized preservation methods. Repair may also include the limited replacement in kind—or with compatible substitute material—of those extensively deteriorated or missing parts of features where there are surviving prototypes such as brackets, molding, or sections of siding.

Replace

Replacing in kind an entire wood feature that is too deteriorated to repair—if the overall form and detailing are still evident—using the physical evidence as a model to reproduce the feature. Examples of wood features include a cornice, entablature or balustrade. If using the same kind of material is not technically or economically feasible, then a compatible substitute material may be considered.

Not Recommended

Using new colors that are inappropriate to the historic building or district.

Failing to undertake adequate measures to assure the protection of wood features.

Replacing an entire wood feature such as a cornice or wall when repair of the wood and limited replacement of deteriorated or missing parts are appropriate.

Using substitute material for the replacement part that does not convey the visual appearance of the surviving parts of the wood feature or that is physically or chemically incompatible.

Removing an entire wood feature that is unrepairable and not replacing it; or replacing it with a new feature that does not convey the same visual appearance.



To replace deteriorated portions of the column, strips of new wood were milled to conform to the shape and appearance of the old column framework, glued in place, then back-primed and painted.

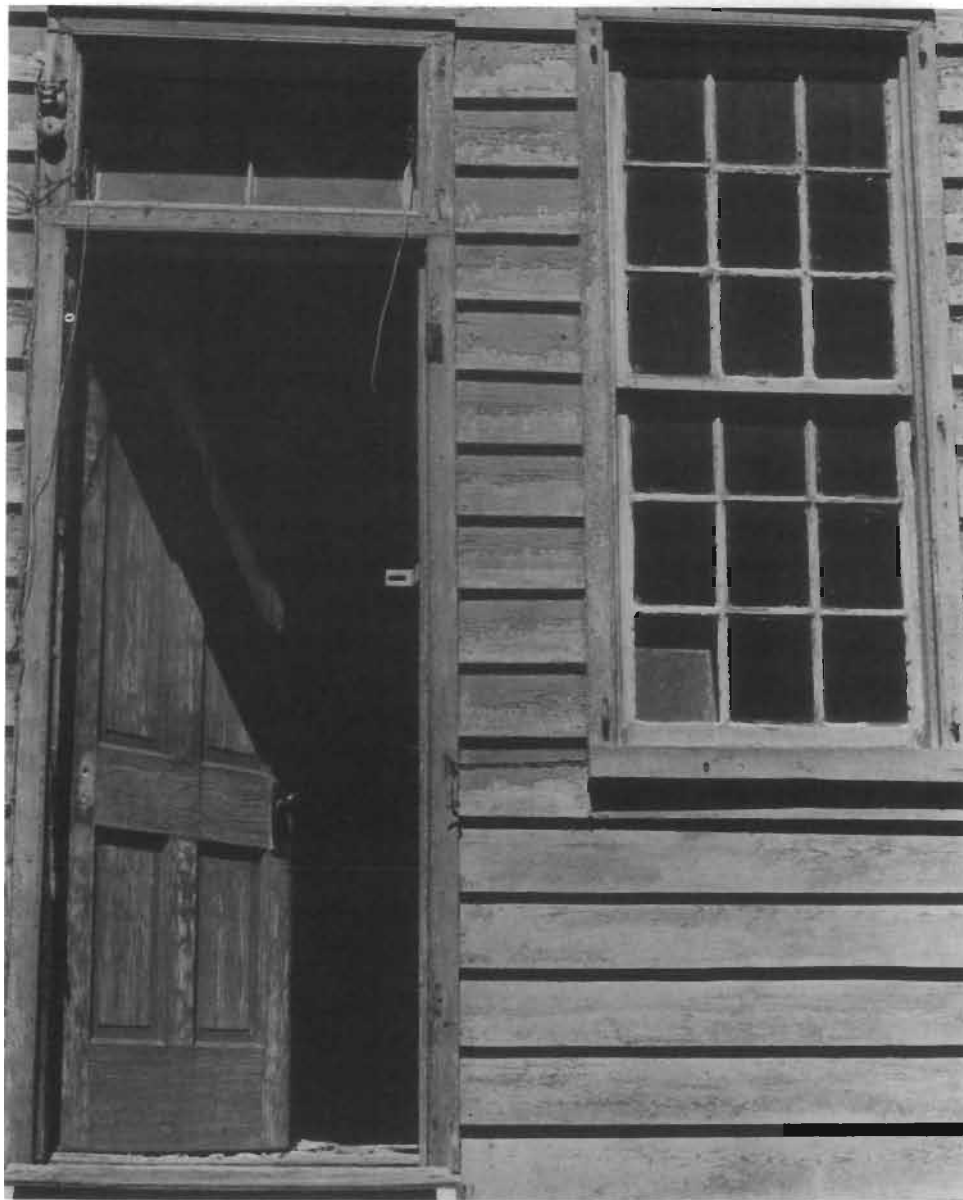

Design for Missing Historic Features

The following work is highlighted to indicate that it represents the particularly complex technical or design aspects of rehabilitation projects and should only be considered after the preservation concerns listed above have been addressed.

Recommended

Designing and installing a new wood feature such as a cornice or doorway when the historic feature is completely missing. It may be an accurate restoration using historical, pictorial, and physical documentation; or be a new design that is compatible with the size, scale, material, and color of the historic building.

Not Recommended

Creating a false historical appearance because the replaced wood feature is based on insufficient historical, pictorial, and physical documentation.

Introducing a new wood feature that is incompatible in size, scale, material and color.

As protection from the extremes of weather, paint should be re-applied to exterior wood on a regular basis.



Building Exterior

Architectural Metals

CAST IRON

STEEL

PRESSED TIN

COPPER

ALUMINUM

ZINC

Building Exterior

Architectural Metals

Architectural metal features—such as cast iron facades, porches, and steps; sheet metal cornices, siding, roofs, roof cresting and storefronts; and cast or rolled metal doors, window sash, entablatures, and hardware—are often highly decorative and may be important in defining the overall historic character of the building.

Metals commonly used in historic buildings include lead, tin, zinc, copper, bronze, brass, iron, steel, and to a lesser extent, nickel alloys, stainless steel and aluminum. Historic metal building components were often created by highly skilled, local artisans, and by the late 19th century, many of these components were prefabricated and readily available from catalogs in standardized sizes and designs.

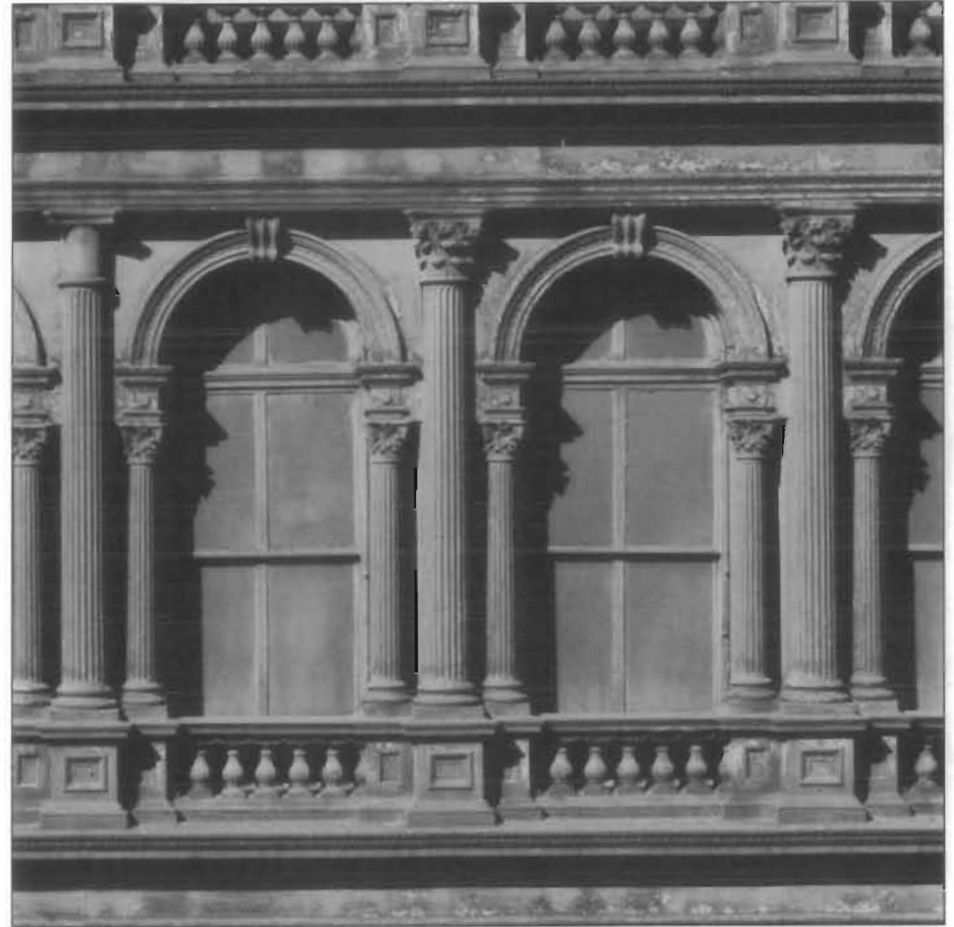



The decorative cast-iron storefront column was sandblasted in order to remove flaking paint and rust prior to repainting. Unlike soft metals such as copper and tin, which are damaged by abrasive cleaning, sandblasting is an appropriate method for cleaning cast iron, a very hard metal.

Recommended

Identify, retain, and preserve

Identifying, retaining, and preserving architectural metal features such as columns, capitals, window hoods, or stairways that are important in defining the overall historic character of the building; and their finishes and colors. Identification is also critical to differentiate between metals prior to work. Each metal has unique properties and thus requires different treatments.

Protect and maintain

Protecting and maintaining architectural metals from corrosion by providing proper drainage so that water does not stand on flat, horizontal surfaces or accumulate in curved, decorative features.

Cleaning architectural metals, when appropriate, to remove corrosion prior to repainting or applying other appropriate protective coatings.

Identifying the particular type of metal prior to any cleaning procedure and then testing to assure that the gentlest cleaning method possible is selected or determining that cleaning is inappropriate for the particular metal.

Not Recommended

Removing or radically changing architectural metal features which are important in defining the overall historic character of the building so that, as a result, the character is diminished.

Removing a major portion of the historic architectural metal from a facade instead of repairing or replacing only the deteriorated metal, then reconstructing the facade with new material in order to create a uniform, or “improved” appearance.

Radically changing the type of finish or its historic color or accent scheme.

Failing to identify, evaluate, and treat the causes of corrosion, such as moisture from leaking roofs or gutters.

Placing incompatible metals together without providing a reliable separation material. Such incompatibility can result in galvanic corrosion of the less noble metal, e.g., copper will corrode cast iron, steel, tin, and aluminum.

Exposing metals which were intended to be protected from the environment.

Applying paint or other coatings to metals such as copper, bronze, or stainless steel that were meant to be exposed.

Using cleaning methods which alter or damage the historic color, texture, and finish of the metal; or cleaning when it is inappropriate for the metal.

Removing the patina of historic metal. The patina may be a protective coating on some metals, such as bronze or copper, as well as a significant historic finish.

Recommended

Cleaning soft metals such as lead, tin, copper, terneplate, and zinc with appropriate chemical methods because their finishes can be easily abraded by blasting methods.

Using the gentlest cleaning methods for cast iron, wrought iron, and steel—hard metals—in order to remove paint buildup and corrosion. If handscraping and wire brushing have proven ineffective, low pressure grit blasting may be used as long as it does not abrade or damage the surface.

Although these pressed metal storefronts have been well maintained over the years, gaps in the seams between the metal sheets above the door and slight stains along the cornice line indicate a possible roof leak. The roof should be investigated and repaired before the moisture results in rust and more severe metal deterioration.

Not Recommended

Cleaning soft metals such as lead, tin, copper, terneplate, and zinc with grit blasting which will abrade the surface of the metal.

Failing to employ gentler methods prior to abrasively cleaning cast iron, wrought iron or steel; or using high pressure grit blasting.

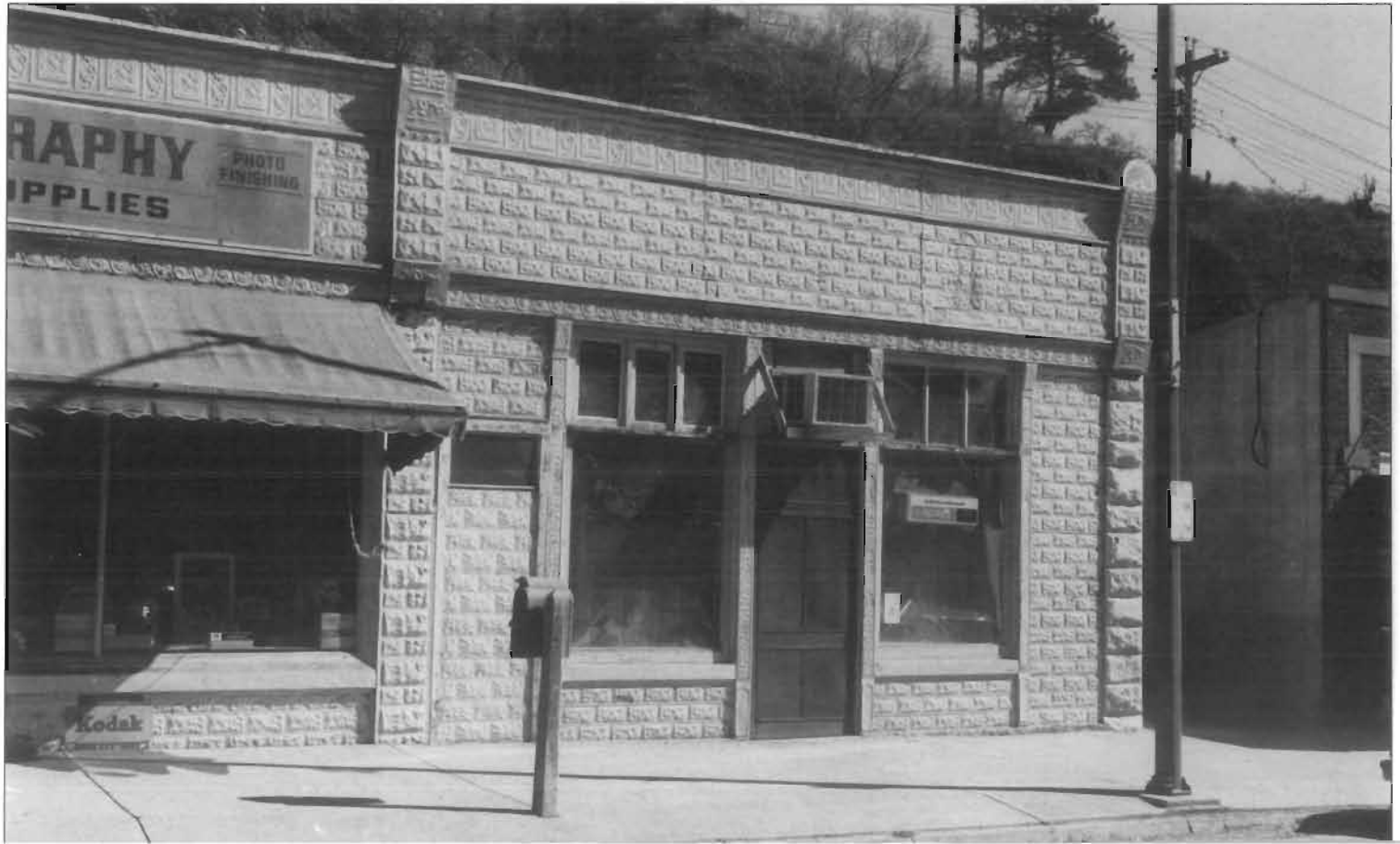

Recommended

Applying appropriate paint or other coating systems after cleaning in order to decrease the corrosion rate of metals or alloys.

Repainting with colors that are appropriate to the historic building or district.

Not Recommended

Failing to re-apply protective coating systems to metals or alloys that require them after cleaning so that accelerated corrosion occurs.

Using new colors that are inappropriate to the historic building or district.



Photo: Jack E. Boucher, HABS.

Deteriorated portions of the decorative pressed metal cornice have been inappropriately replaced with non-matching, plain metal sheets, adversely affecting the historic character of this building.

Applying an appropriate protective coating such as lacquer to an architectural metal feature such as a bronze door which is subject to heavy pedestrian use.

Evaluating the overall condition of the architectural metals to determine whether more than protection and maintenance are required, that is, if repairs to features will be necessary.

Failing to assess pedestrian use or new access patterns so that architectural metal features are subject to damage by use or inappropriate maintenance such as salting adjacent sidewalks.

Failing to undertake adequate measures to assure the protection of architectural metal features.



The cast-iron columns of this theater are being repaired during rehabilitation. Some of the cast iron elements such as the smaller, non-structural columns missing from the bay on the right will be replaced with a lightweight substitute material such as cast aluminum, an acceptable alternative according to the Standards.

Recommended

Repair

Repairing architectural metal features by patching, splicing, or otherwise reinforcing the metal following recognized preservation methods. Repairs may also include the limited replacement in kind—or with a compatible substitute material—of those extensively deteriorated or missing parts of features when there are surviving prototypes such as porch balusters, column capitals or bases; or porch cresting.

Replace

Replacing in kind an entire architectural metal feature that is too deteriorated to repair—if the overall form and detailing are still evident—using the physical evidence as a model to reproduce the feature. Examples could include cast iron porch steps or steel sash windows. If using the same kind of material is not technically or economically feasible, then a compatible substitute material may be considered.

Not Recommended

Replacing an entire architectural metal feature such as a column or a balustrade when repair of the metal and limited replacement of deteriorated or missing parts are appropriate.

Using a substitute material for the replacement part that does not convey the visual appearance of the surviving parts of the architectural metal feature or is that physically or chemically incompatible.

Removing an architectural metal feature that is unrepairable and not replacing it; or replacing it with a new architectural metal feature that does not convey the same visual appearance.

The following work is highlighted to indicate that it represents the particularly complex technical or design aspects of rehabilitation projects and should only be considered after the preservation concerns listed above have been addressed.

Recommended

Design for Missing Historic Features

Designing and installing a new architectural metal feature such as a metal cornice or cast iron capital when the historic feature is completely missing. It may be an accurate restoration using historical, pictorial, and physical documentation; or be a new design that is compatible with the size, scale, material, and color of the historic building.

Not Recommended

Creating a false historical appearance because the replaced architectural metal feature is based on insufficient historical, pictorial, and physical documentation.

Introducing a new architectural metal feature that is incompatible in size, scale, material and color.

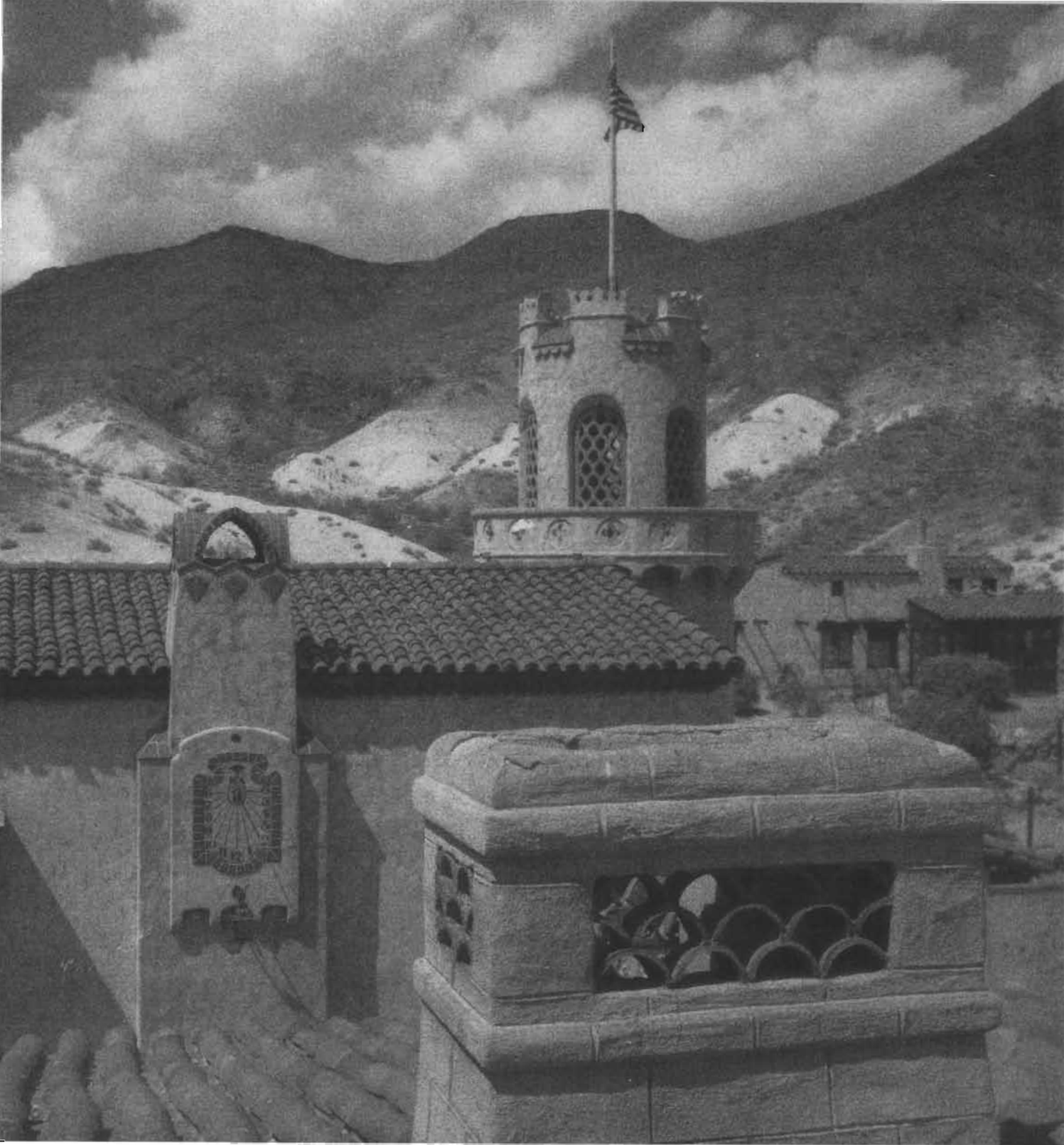

Building
Exterior

Roofs

Building Exterior

Roofs

The roof—with its shape; features such as cresting, dormers, cupolas, and chimneys; and the size, color, and patterning of the roofing material—is an important design element of many historic buildings. In addition, a weather tight roof is essential to the longterm preservation of the entire structure. Historic roofing reflects availability of materials, levels of construction technology, weather, and cost. For example, throughout the country in all periods of history, wood shingles have been used—their size, shape, and detailing differing according to regional craft practices. European settlers used clay tile for roofing as early as the mid-17th century. In some cities, such as New York and Boston, clay was popularly used as a precaution against fire. The Spanish influence in the use of clay tiles is found in the southern, southwestern and western states. In the mid-19th century, tile roofs were often replaced by sheet-metal, which is lighter and easier to maintain. Evidence of the use

of slate for roofing dates from the mid-17th century. Slate has remained popular for its durability, fireproof qualities, and decorative applications. The use of metals for roofing and roof features dates from the 18th century, and includes the use of sheet iron, corrugated iron, galvanized metal, tinplate, copper, lead and zinc. Awareness of these and other traditions of roofing materials and their detailing will contribute to more sensitive treatment.



Recommended

Identify, retain, and preserve

Identifying, retaining, and preserving roofs—and their functional and decorative features—that are important in defining the overall historic character of the building. This includes the roof's shape, such as hipped, gambrel, and mansard; decorative features such as cupolas, cresting, chimneys, and weathervanes; and roofing material such as slate, wood, clay tile, and metal, as well as its size, color, and patterning.

This well-maintained mansard roof displays its handsome and varied decorative detailing—cast-iron cresting, wood shingles, and pedimented dormers.



Protect

Protecting and maintaining a roof by cleaning the gutters and downspouts and replacing deteriorated flashing. Roof sheathing should also be checked for proper venting to prevent moisture condensation and water penetration; and to insure that materials are free from insect infestation.

Not Recommended

Radically changing, damaging, or destroying roofs which are important in defining the overall historic character of the building so that, as a result, the character is diminished.

Removing a major portion of the roof or roofing material that is repairable, then reconstructing it with new material in order to create a uniform, or “improved” appearance.

Changing the configuration of a roof by adding new features such as dormer windows, vents, or skylights so that the historic character is diminished.

Stripping the roof of sound historic material such as slate, clay tile, wood, and architectural metal.

Applying paint or other coatings to roofing material which has been historically uncoated.

Failing to clean and maintain gutters and downspouts properly so that water and debris collect and cause damage to roof fasteners, sheathing, and the underlying structure.

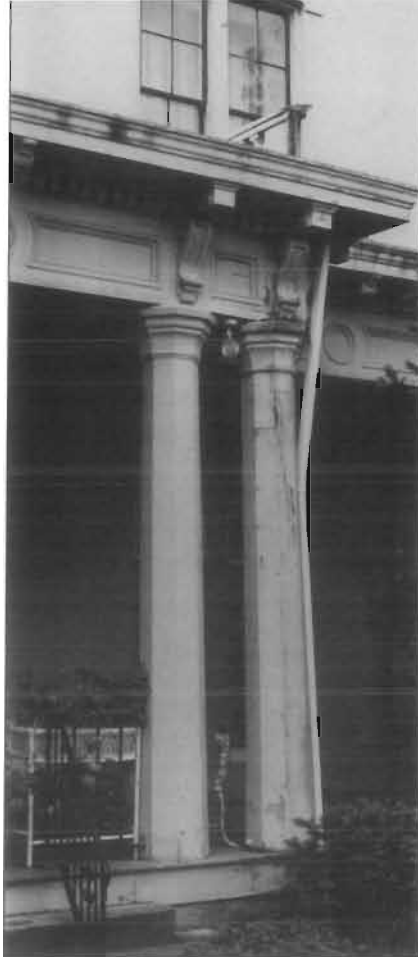

The roof drainage system has been neglected for such a long time that, as a result, the wood cornice and a porch column are both severely deteriorated.

Recommended

Providing adequate anchorage for roofing material to guard against wind damage and moisture penetration.

Protecting a leaking roof with plywood and building paper until it can be properly repaired.

Repair

Repairing a roof by reinforcing the historic materials which comprise roof features. Repairs will also generally include the limited replacement in kind—or with compatible substitute material—of those extensively deteriorated or missing parts of features when there are surviving prototypes such as cupola louvers, dentils, dormer roofing; or slates, tiles, or wood shingles on a main roof.

New copper valley flashing is installed as part of overall repairs to the historic slate roof and its drainage system.

Not Recommended

Allowing roof fasteners, such as nails and clips to corrode so that roofing material is subject to accelerated deterioration.

Permitting a leaking roof to remain unprotected so that accelerated deterioration of historic building materials—masonry, wood, plaster, paint and structural members—occurs.

Replacing an entire roof feature such as a cupola or dormer when repair of the historic materials and limited replacement of deteriorated or missing parts are appropriate.

Failing to reuse intact slate or tile when only the roofing substrate needs replacement.

Using a substitute material for the replacement part that does not convey the visual appearance of the surviving parts of the roof or that is physically or chemically incompatible.



Photo: Richard Cheek

Recommended

Replace

Replacing in kind an entire feature of the roof that is too deteriorated to repair—if the overall form and detailing are still evident—using the physical evidence as a model to reproduce the feature. Examples can include a large section of roofing, or a dormer or chimney. If using the same kind of material is not technically or economically feasible, then a compatible substitute material may be considered.



The size, shape, and detailing of the historic shingles as well as the method of fabrication and installation were carefully researched prior to selecting this new wood-shingle roofing.

Not Recommended

Removing a feature of the roof that is unrepairable, such as a chimney or dormer, and not replacing it; or replacing it with a new feature that does not convey the same visual appearance.



Workmen are in the process of removing deteriorated roofing slates and replacing them with new matching slates.

New galvanized sheet-iron shingles will need to be reproduced using the pattern of the original shingle.



The following work is highlighted to indicate that it represents the particularly complex technical or design aspects of rehabilitation projects and should only be considered after the preservation concerns listed above have been addressed.

Recommended

Design for Missing Historic Features

Designing and constructing a new feature when the historic feature is completely missing, such as chimney or cupola. It may be an accurate restoration using historical, pictorial, and physical documentation; or be a new design that is compatible with the size, scale, material, and color of the historic building.

Alterations/Additions for the New Use

Installing mechanical and service equipment on the roof such as air conditioning, transformers, or solar collectors when required for the new use so that they are inconspicuous from the public right-of-way and do not damage or obscure character-defining features.

Designing additions to roofs such as residential, office, or storage spaces; elevator housing; decks and terraces; or dormers or skylights when required by the new use so that they are inconspicuous from the public right-of-way and do not damage or obscure character-defining features.

Not Recommended

Creating a false historical appearance because the replaced feature is based on insufficient historical, pictorial, and physical documentation.

Introducing a new roof feature that is incompatible in size, scale, material and color.

Installing mechanical or service equipment so that it damages or obscures character-defining features; or is conspicuous from the public right-of-way.

Radically changing a character-defining roof shape or damaging or destroying character-defining roofing material as a result of incompatible design or improper installation techniques.

Building
Exterior
Windows

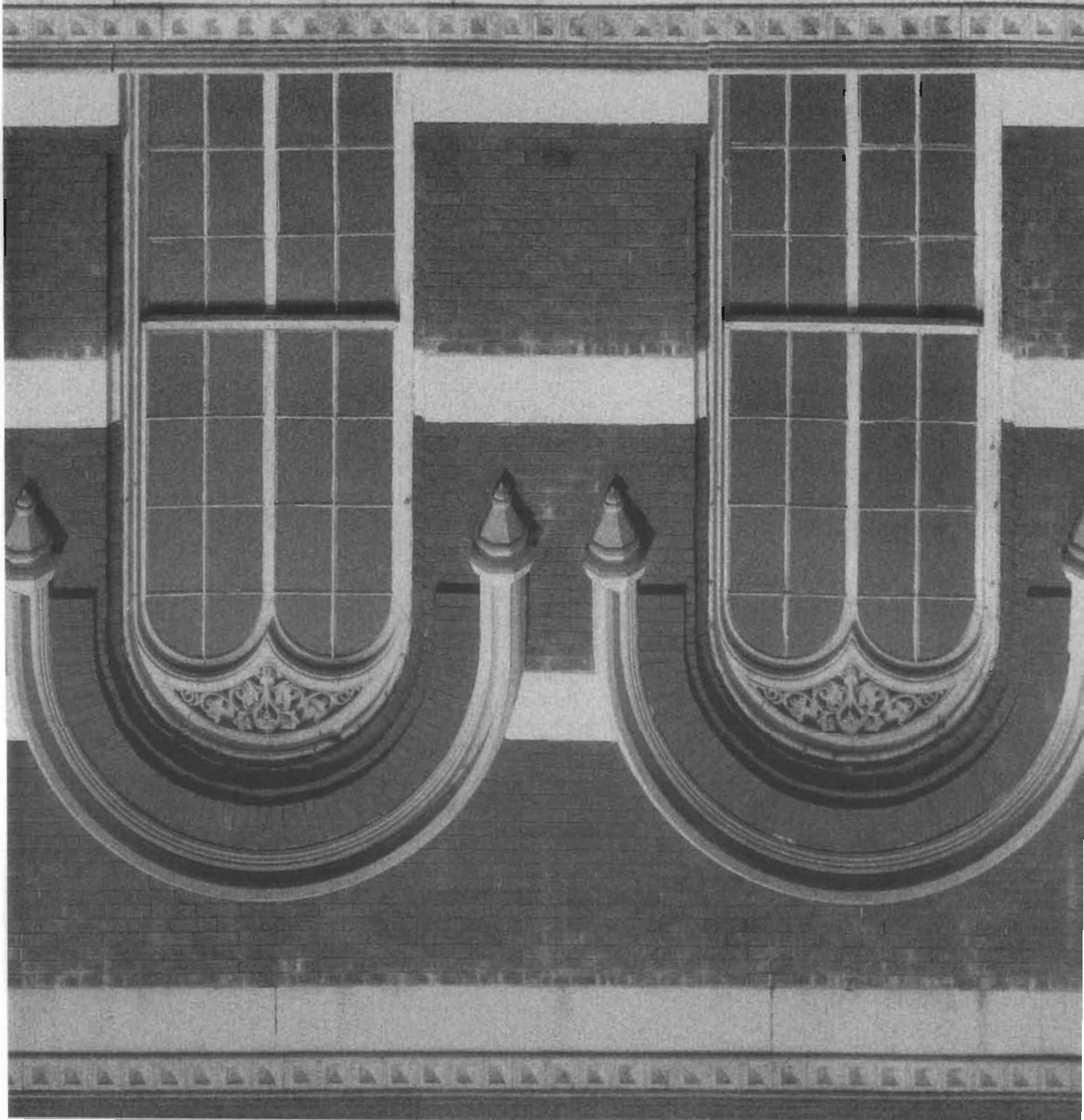

Building Exterior *Windows*

Technology and prevailing architectural styles have shaped the history of windows in the United States starting in the 17th century with wooden casement windows with tiny glass panes seated in lead cames. From the transitional single-hung sash in the early 1700s to the true double-hung sash later in the same century, these early wooden windows were characterized by the small panes, wide muntins, and the way in which decorative trim was used on both the exterior and interior of the window. As the sash thickness increased by the turn of the century, muntins took on a thinner appearance as they narrowed in width but increased in thickness according to the size of the window and design practices. Regional traditions continued to have an impact on the prevailing window design such as with the long-term use of “french windows” in areas of the deep South.

Changes in technology led to the possibility of larger glass panes so that by the mid-19th century, two-over-two lights were common; the manufacturing of plate glass in the United States allowed

for dramatic use of large sheets of glass in commercial and office buildings by the late 19th century. With mass-produced windows, mail order distribution, and changing architectural styles, it was possible to obtain a wide range of window designs and light patterns in sash. Popular versions of Arts and Crafts houses constructed in the early 20th century frequently utilized smaller lights in the upper sash set in groups or pairs and saw the re-emergence of casement windows. In the early 20th century, the desire for fireproof building construction in dense urban areas contributed to the growth of a thriving steel window industry along with a market for hollow metal and metal clad wooden windows.

As one of the few parts of a building serving as both an interior and exterior feature, windows are nearly always an important part of the historic character of a building. In most buildings, windows also comprise a considerable amount of the historic fabric of the wall plane and thus are deserving of special consideration in a rehabilitation project.

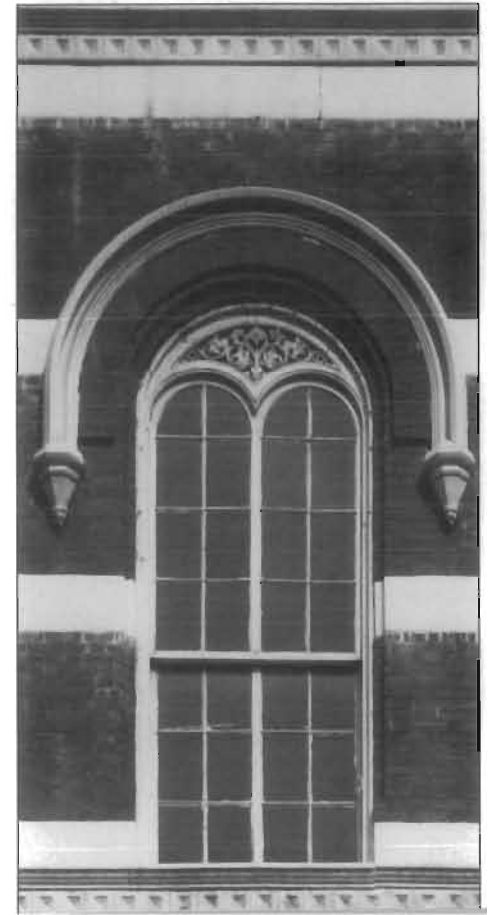

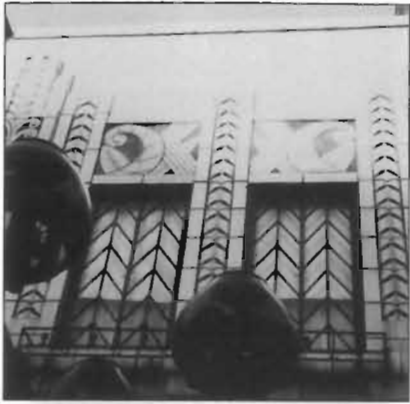

Recommended

Identify, retain, and preserve

Identifying, retaining, and preserving windows — and their functional and decorative features — that are important in defining the overall historic character of the building. Such features can include frames, sash, muntins, glazing, sills, heads, hoodmolds, panelled or decorated jambs and moldings, and interior and exterior shutters and blinds.

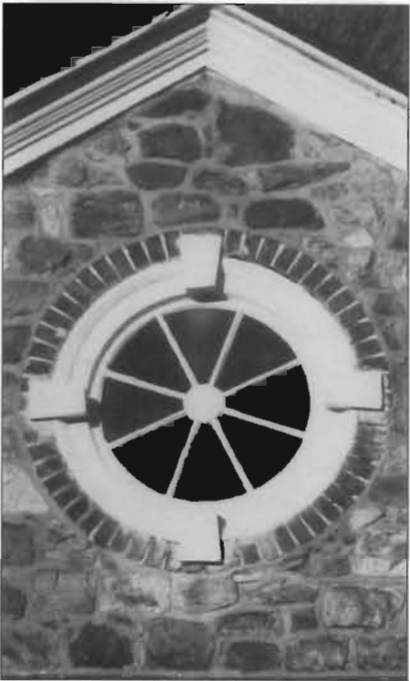

Conducting an in-depth survey of the conditions of existing windows early in rehabilitation planning so that repair and upgrading methods and possible replacement options can be fully explored.

Protect and maintain

Protecting and maintaining the wood and architectural metal which comprise the window frame, sash, muntins, and surrounds through appropriate surface treatments such as cleaning, rust removal, limited paint removal, and re-application of protective coating systems.

The distinctive shape and decorative detailing of a building's windows often help establish its architectural style and character.

Not Recommended

Removing or radically changing windows which are important in defining the historic character of the building so that, as a result, the character is diminished.

Changing the number, location, size or glazing pattern of windows, through cutting new openings, blocking-in windows, and installing replacement sash that do not fit the historic window opening.

Changing the historic appearance of windows through the use of inappropriate designs, materials, finishes, or colors which noticeably change the sash, depth of reveal, and muntin configuration; the reflectivity and color of the glazing; or the appearance of the frame.

Obscuring historic window trim with metal or other material.

Stripping windows of historic material such as wood, cast iron, and bronze.

Replacing windows solely because of peeling paint, broken glass, stuck sash, and high air infiltration. These conditions, in themselves, are no indication that windows are beyond repair.

Failing to provide adequate protection of materials on a cyclical basis so that deterioration of the windows results.



Maintaining a historic window may include work as basic as replacing a sash cord.

Recommended

Making windows weather tight by re-caulking and replacing or installing weatherstripping. These actions also improve thermal efficiency.

Evaluating the overall condition of materials to determine whether more than protection and maintenance are required, i.e. if repairs to windows and window features will be required.

Repair

Repairing window frames and sash by patching, splicing, consolidating or otherwise reinforcing. Such repair may also include replacement in kind of those parts that are either extensively deteriorated or are missing when there are surviving prototypes such as architraves, hoodmolds, sash, sills, and interior or exterior shutters and blinds.

Not Recommended

Retrofitting or replacing windows rather than maintaining the sash, frame, and glazing.

Failing to undertake adequate measures to assure the protection of historic windows.

Replacing an entire window when repair of materials and limited replacement of deteriorated or missing parts are appropriate.

Failing to reuse serviceable window hardware such as brass sash lifts and sash locks.

Using substitute material for the replacement part that does not convey the visual appearance of the surviving parts of the window or that is physically or chemically incompatible.

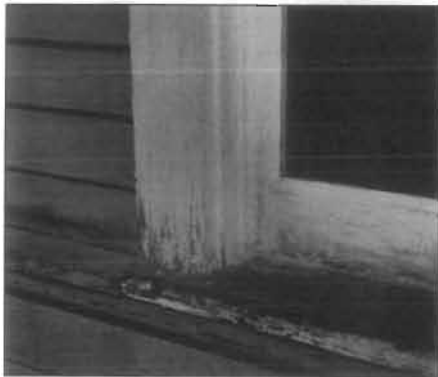

Deterioration of poorly maintained windows usually begins on horizontal surfaces where water collects. Problem areas on this sill are clearly indicated by paint failure due to moisture.

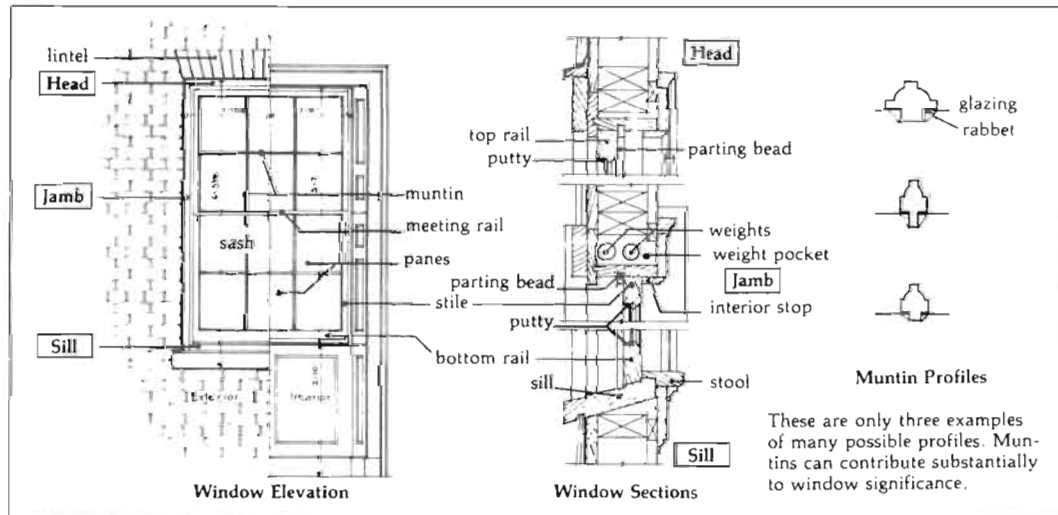

These are only three examples of many possible profiles. Muntins can contribute substantially to window significance.

These drawings identify individual parts and fabrication details of a historic wooden double-hung window.

Recommended

Replace

Replacing in kind an entire window that is too deteriorated to repair using the same sash and pane configuration and other design details. If using the same kind of material is not technically or economically feasible when replacing windows deteriorated beyond repair, then a compatible substitute material may be considered. For example, on certain types of large buildings, particularly high-rises, aluminum windows may be a suitable replacement for historic wooden sash provided wooden replacement are not practical and the design detail of the historic windows can be matched. Historic color duplication, custom contour panning, incorporation of either an integral muntin or 5/8" deep trapezoidal exterior muntin grids, where applicable, retention of the same glass to frame ratio, matching of the historic reveal, and duplication of the frame width, depth, and such existing decorative details as arched tops should all be components in aluminum replacements for use on historic buildings.

For some larger buildings, it may be appropriate to replace seriously deteriorated windows with new ones that replicate most of the historic visual qualities. This two-part drawing shows the original windows in a mill and the rehabilitation solution that retained the wood frames, then utilized an aluminum sash with true divided lights and a piggyback interior storm panel.

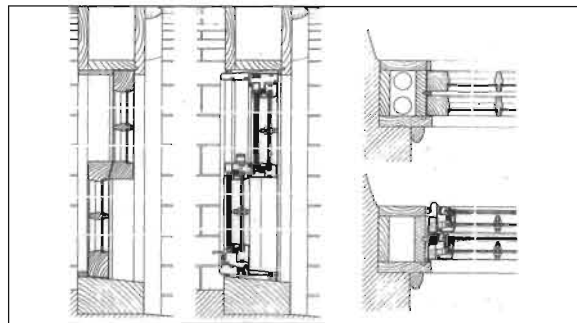

Not Recommended

Removing a character-defining window that is unrepairable and blocking it in; or replacing it with a new window that does not convey the same visual appearance.

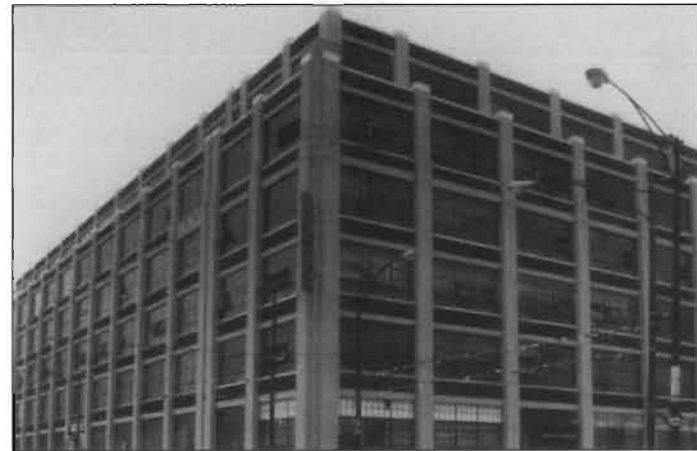

The steel pivot windows in this historic manufacturing building were replaced with new windows which matched the multi-lighted originals.

The following work is highlighted to indicate that it represents the particularly complex technical or design aspects of rehabilitation projects and should only be considered after the preservation concerns listed above have been addressed.

Recommended

Design for Missing Historic Features

Designing and installing new windows when the historic windows (frames, sash and glazing) are completely missing. The replacement windows may be an accurate restoration using historical, pictorial, and physical documentation; or be a new design that is compatible with the window openings and the historic character of the building.

Alterations/Additions for the New Use

Designing and installing additional windows on rear or other non-character-defining elevations if required by the new use. New window openings may also be cut into exposed party walls. Such design should be compatible with the overall design of the building, but not duplicate the fenestration pattern and detailing of a character-defining elevation.

Providing a setback in the design of dropped ceilings when they are required for the new use to allow for the full height of the window openings.

Not Recommended

Creating a false historical appearance because the replaced window is based on insufficient historical, pictorial, and physical documentation.

Introducing a new design that is incompatible with the historic character of the building.

Installing new windows, including frames, sash, and muntin configuration that are incompatible with the building's historic appearance or obscure, damage, or destroy character-defining features.

Inserting new floors or furred-down ceilings which cut across the glazed areas of windows so that the exterior form and appearance of the windows are changed.



When the six-over-six windows were replaced with inappropriate single sheets of tinted glass, the historic industrial character of this building was lost.



Building Exterior

Entrances and Porches

Building Exterior

Entrances and Porches

Entrances and porches are quite often the focus of historic buildings, particularly on primary elevations. Together with their functional and decorative features such as doors, steps, balustrades, pilasters, and entablatures, they can be extremely important in defining the overall character of a building. In many cases, porches were energy-saving devices, shading southern and western elevations. Usually entrances and porches were integral components of a historic building's design; for example, porches on Greek Revival houses, with Doric or Ionic columns and pediments, echoed the architectural elements and features of the larger building. Central one-bay porches or arcaded porches are evident in Italianate style buildings of the 1860s. Doors of Renaissance Revival style buildings frequently supported entablatures or pedi-

ments. Porches were particularly prominent features of Eastlake and Stick Style houses; porch posts, railings, and balusters were characterized by a massive and robust quality, with members turned on a lathe. Porches of bungalows of the early 20th century were characterized by tapered porch posts, exposed post and beams, and low pitched roofs with wide overhangs. Art Deco commercial buildings were entered through stylized glass and stainless steel doors.





Recommended

Identify, retain, and preserve

Identifying, retaining, and preserving entrances—and their functional and decorative features—that are important in defining the overall historic character of the building such as doors, fanlights, sidelights, pilasters, entablatures, columns, balustrades, and stairs.



Protect and maintain

Protecting and maintaining the masonry, wood, and architectural metal that comprise entrances and porches through appropriate surface treatments such as cleaning, rust removal, limited paint removal, and re-application of protective coating systems.

Evaluating the overall condition of materials to determine whether more than protection and maintenance are required, that is, if repairs to entrance and porch features will be necessary.

Photos: Jack Boucher, HABS.

A variety of historic entrances and porches is illustrated here, ranging from the elegance of a Georgian-style entrance, to the more vernacular nature of a 19th century wood porch, to the utilitarian, yet romantic Mediterranean-style loggia.



Not Recommended

Removing or radically changing entrances and porches which are important in defining the overall historic character of the building so that, as a result, the character is diminished.

Stripping entrances and porches of historic material such as wood, cast iron, terra cotta tile, and brick.

Removing an entrance or porch because the building has been re-oriented to accommodate a new use.

Cutting new entrances on a primary elevation.

Altering utilitarian or service entrances so they appear to be formal entrances by adding panelled doors, fanlights, and sidelights.

Failing to provide adequate protection to materials on a cyclical basis so that deterioration of entrances and porches results.

Failing to undertake adequate measures to assure the protection of historic entrances and porches.

Recommended

Repair

Repairing entrances and porches by reinforcing the historic materials. Repair will also generally include the limited replacement in kind—or with compatible substitute material—of those extensively deteriorated or missing parts of repeated features where there are surviving prototypes such as balustrades, cornices, entablatures, columns, sidelights, and stairs.

In the 19th century some cast-iron porches could be purchased by mail, such as this made-to-order veranda which was featured in an 1870 foundry catalog.



Not Recommended

Replacing an entire entrance or porch when the repair of materials and limited replacement of parts are appropriate.

Using a substitute material for the replacement parts that does not convey the visual appearance of the surviving parts of the entrance and porch or that is physically or chemically incompatible.



Careful inspection of porch features such as these column capitals is necessary before initiating a rehabilitation project.

Recommended

Replace

Replacing in kind an entire entrance or porch that is too deteriorated to repair—if the form and detailing are still evident—using the physical evidence as a model to reproduce the feature. If using the same kind of material is not technically or economically feasible, then a compatible substitute material may be considered.



Not Recommended

Removing an entrance or porch that is unrepairable and not replacing it; or replacing it with a new entrance or porch that does not convey the same visual appearance.

A 1910 wrap-around porch was removed from this 1830 house during rehabilitation. Although a later addition, the porch should not have been removed because it had acquired significance over time and was thus an important feature in defining the character of this historic structure.



The following work is highlighted to indicate that it represents the particularly complex technical or design aspects of rehabilitation projects and should only be considered after the preservation concerns listed above have been addressed.

Recommended

Design for Missing Historic Features

Designing and constructing a new entrance or porch when the historic entrance or porch is completely missing. It may be a restoration based on historical, pictorial, and physical documentation; or be a new design that is compatible with the historic character of the building.

Alterations/Additions for the New Use

Designing enclosures for historic porches when required by the new use in a manner that preserves the historic character of the building. This can include using large sheets of glass and recessing the enclosure wall behind existing scrollwork, posts, and balustrades.

Designing and installing additional entrances or porches when required for the new use in a manner that preserves the historic character of the buildings, i.e., limiting such alteration to non-character-defining elevations.

Not Recommended

Creating a false historical appearance because the replaced entrance or porch is based on insufficient historical, pictorial, and physical documentation.

Introducing a new entrance or porch that is incompatible in size, scale, material, and color.

Enclosing porches in a manner that results in a diminution or loss of historic character such as using solid materials such as wood, stucco, or masonry.

Installing secondary service entrances and porches that are incompatible in size and scale with the historic building or obscure, damage, or destroy character-defining features.

This rehabilitation connected two separate porches, resulting in the creation of a large continuous porch that obscures the historic twin porch design; it is thus incompatible with the historic character of the house.





Building
Exterior

Storefronts

Building Exterior

Storefronts

The storefront is usually the most prominent feature of a historic commercial building, playing a crucial role in a store's advertising and merchandising strategy. Although a storefront normally does not extend beyond the first story, the rest of the building is often related to it visually through a unity of form and detail. Planning should always consider the entire building; window patterns on the upper floors, cornice elements, and other decorative features should be carefully retained, in addition to the storefront itself.

The earliest extant storefronts in the U.S., dating from the late 18th and early 19th centuries, had bay or oriel windows and provided limited display space. The 19th century witnessed the progressive enlargement of display windows

as plate glass became available in increasingly larger units. The use of cast iron columns and lintels at ground floor level permitted structural members to be reduced in size. Recessed entrances provided shelter for sidewalk patrons and further enlarged display areas. In the 1920s and 1930s, aluminum, colored structural glass, stainless steel, glass block, neon, and other new materials were introduced to create Art Deco storefronts.



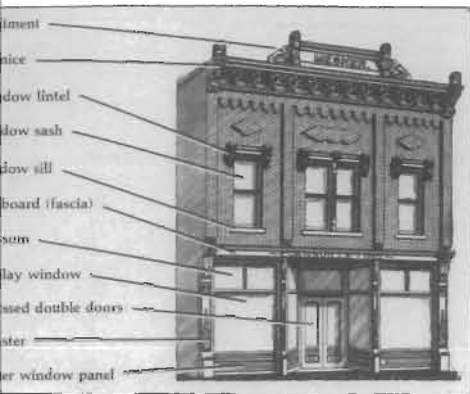

These architectural details are typical of historic commercial buildings (this particular one is No. 4016 in the George L. Mesker and Company catalog of 1905). The design utilized both cast and galvanized iron.

Recommended

Identify, retain, and preserve

Identifying, retaining, and preserving storefronts—and their functional and decorative features—that are important in defining the overall historic character of the building such as display windows, signs, doors, transoms, kick plates, corner posts, and entablatures. The removal of inappropriate, nonhistoric cladding, false mansard roofs, and other later alterations can help reveal the historic character of a storefront.

Protect

Protecting and maintaining masonry, wood, and architectural metals which comprise storefronts through appropriate treatments such as cleaning, rust removal, limited paint removal, and reapplication of protective coating systems.

Protecting storefronts against arson and vandalism before work begins by boarding up windows and installing alarm systems that are keyed into local protection agencies.

Not Recommended

Removing or radically changing storefronts—and their features—which are important in defining the overall historic character of the building so that, as a result, the character is diminished.

Changing the storefront so that it appears residential rather than commercial in character.

Removing historic material from the storefront to create a recessed arcade.

Introducing coach lanterns, mansard designs, wood shakes, nonoperable shutters, and small-paned windows if they cannot be documented historically.

Changing the location of a storefront's main entrance.

Failing to provide adequate protection of materials on a cyclical basis so that deterioration of storefront features results.

Permitting entry into the building through unsecured or broken windows and doors so that interior features and finishes are damaged through exposure to weather or through vandalism.

Stripping storefronts of historic material such as wood, cast iron, terra cotta, carrara glass, and brick.

Recommended

Evaluating the overall condition of storefront materials to determine whether more than protection and maintenance are required, that is, if repairs to features will be necessary.

Not Recommended

Failing to undertake adequate measures to assure the preservation of the historic storefront.



Photos: Jack E. Brecher, HABS.

A false-fronted wood store is now used as a museum. Although the weathered wood is part of its charm, repainting is recommended as a good maintenance practice to protect the wood.

Repair

Repairing storefronts by reinforcing the historic materials. Repairs will also generally include the limited replacement in kind—or with compatible substitute materials—of those extensively deteriorated or missing parts of storefronts where there are surviving prototypes such as transoms, kick plates, pilasters, or signs.

Replacing an entire storefront when repair of materials and limited replacement of its parts are appropriate.

Using substitute material for the replacement parts that does not convey the same visual appearance as the surviving parts of the storefront or that is physically or chemically incompatible.

This sleek red and black Moderne storefront was added to a more staid late-19th century commercial building in the 1930s—both are now in need of repair. According to the Standards, later storefronts that have acquired significance over time should generally be retained in rehabilitation.



Recommended

Replace

Replacing in kind an entire storefront that is too deteriorated to repair—if the overall form and detailing are still evident—using the physical evidence as a model. If using the same material is not technically or economically feasible, then compatible substitute materials may be considered.

Not Recommended

Removing a storefront that is unrepairable and not replacing it; or replacing it with a new storefront that does not convey the same visual appearance.



This appropriate new storefront replaces an old one that was too deteriorated to save. It features a recessed doorway based on the historic design and respects the scale and proportion of the existing building.



The following work is highlighted to indicate that it represents the particularly complex technical or design aspects of rehabilitation projects and should only be considered after the preservation concerns listed above have been addressed.

Recommended

Design for Missing Historic Features

Designing and constructing a new storefront when the historic storefront is completely missing. It may be an accurate restoration using historical, pictorial, and physical documentation; or be a new design that is compatible with the size, scale, material, and color of the historic building.

Not Recommended

Creating a false historical appearance because the replaced storefront is based on insufficient historical, pictorial, and physical documentation.

Introducing a new design that is incompatible in size, scale, material, and color.

Using inappropriately scaled signs and logos or other types of signs that obscure, damage, or destroy remaining character-defining features of the historic building.



Building
Interior

*Structural
Systems*

Building Interior

Structural Systems

If features of the structural system are exposed such as loadbearing brick walls, cast iron columns, roof trusses, posts and beams, vigas, or stone foundation walls, they may be important in defining the building's overall historic character. Unexposed structural features that are not character-defining or an entire structural system may nonetheless be significant in the history of building technology; therefore, the structural system should always be examined and evaluated early in the project planning stage to determine both its physical condition and its importance to the building's historic character or historical significance.

The types of structural systems found in America include, but certainly are not limited, to the

following: wooden frame construction (17th c.), balloon frame construction (19th c.), load-bearing masonry construction (18th c.), brick cavity wall construction (19th c.), heavy timber post and beam industrial construction (19th c.), fireproof iron construction (19th c.), heavy masonry and steel construction (19th c.), skeletal steel construction (19th c.), and concrete slab and post construction (20th c.).

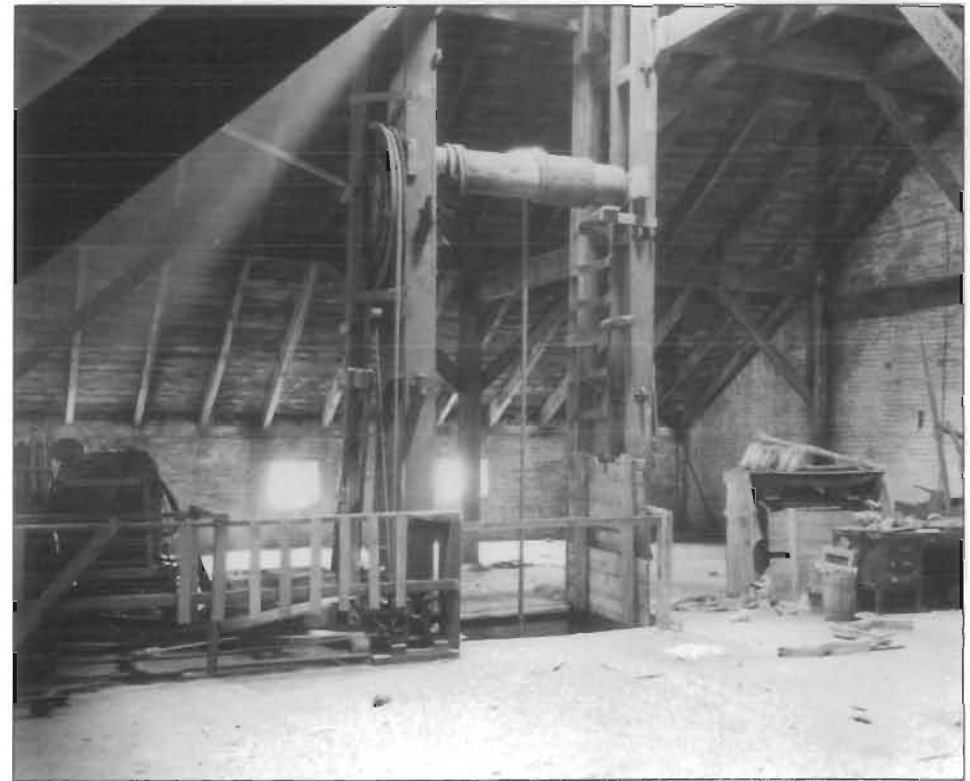

Recommended

Identify, retain, and preserve

Identifying, retaining, and preserving structural systems—and individual features of systems—that are important in defining the overall historic character of the building, such as post and beam systems, trusses, summer beams, vigas, cast iron columns, above-grade stone foundation walls, or loadbearing brick or stone walls.



The exposed metal roof-truss system of this waiting room not only provides structural support, but is also important in defining the interior character of the train station.

Protect and maintain

Protecting and maintaining the structural system by cleaning the roof gutters and downspouts; replacing roof flashing; keeping masonry, wood, and architectural metals in a sound condition; and assuring that structural members are free from insect infestation.

Not Recommended

Removing, covering, or radically changing features of structural systems which are important in defining the overall historic character of the building so that, as a result, the character is diminished.

Putting a new use into the building which could overload the existing structural system; or installing equipment or mechanical systems which could damage the structure.

Demolishing a loadbearing masonry wall that could be augmented and retained, and replacing it with a new wall (i.e., brick or stone), using the historic masonry only as an exterior veneer.

Leaving known structural problems untreated such as deflection of beams, cracking and bowing of walls, or racking of structural members.

Utilizing treatments or products that accelerate the deterioration of structural material such as introducing urea-formaldehyde foam insulation into frame walls.

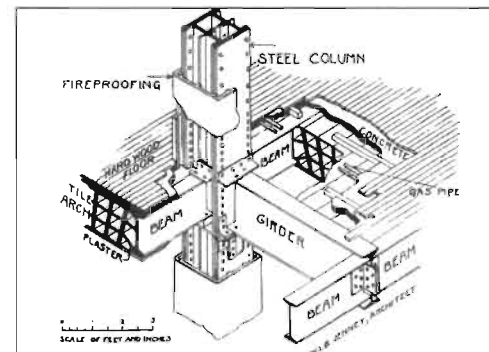

Detail of a column and girder connection and floor construction, The Fair Store, Chicago, Illinois, 1892 (Jenney and Mundie, architects). This type of connection was used in many iron and steel buildings; "fireproofing" was provided by terra-cotta tile and plaster.

Failing to provide proper building maintenance so that deterioration of the structural system results. Causes of deterioration include subsurface ground movement, vegetation growing too close to foundation walls, improper grading, fungal rot, and poor interior ventilation that results in condensation.



Photo: Irving B. Haynes and Associates

In order to preserve this historic wood-frame building, new steel framing was inserted to reinforce the wood post and beam structure. Original wood framing members were notched to accommodate the new steel frame.

Recommended

Examining and evaluating the physical condition of the structural system and its individual features using non-destructive techniques such as X-ray photography.

Repair

Repairing the structural system by augmenting or upgrading individual parts or features. For example, weakened structural members such as floor framing can be paired with a new member, braced, or otherwise supplemented and reinforced.



Iron and Steel Skeleton Frame, Unity Building, Chicago, Illinois, 1891-1892 (Clinton J. Warren, architect). *The development of the skeleton frame was pioneered by architects of the "Chicago School" in the late-19th century. With this method the weight of the building is carried on the frame, not the walls, allowing the construction of taller buildings without increasing the wall thickness.*

Not Recommended

Utilizing destructive probing techniques that will damage or destroy structural material.

Upgrading the building structurally in a manner that diminishes the historic character of the exterior, such as installing strapping channels or removing a decorative cornice; or that damages interior features or spaces.

Replacing a structural member or other feature of the structural system when it could be augmented and retained.

Recommended

Replace

Replacing in kind—or with substitute material—those portions or features of the structural system that are either extensively deteriorated or are missing when there are surviving prototypes such as cast iron columns, roof rafters or trusses, or sections of loadbearing walls. Substitute material should convey the same form, design, and overall visual appearance as the historic feature; and, at a minimum, equal its loadbearing capabilities.

These before and after rehabilitation photographs offer a good example of a project that took into account, and respected, the unique industrial structural character of this mill building in its conversion to a shopping mall.



Not Recommended

Installing a replacement feature that does not convey the same visual appearance, e.g., replacing an exposed wood summer beam with a steel beam.

Using substitute material that does not equal the loadbearing capabilities of the historic material and design or is otherwise physically or chemically incompatible.

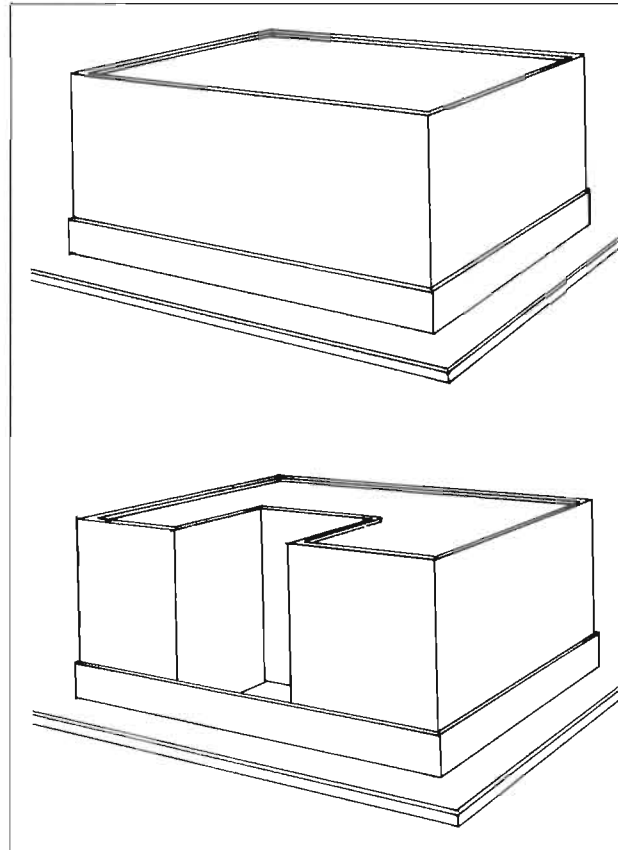

A rehabilitation proposal to convert a historic waterfront warehouse into a residential apartment building called for cutting out a large section of the rectangular-shaped historic building. The new “U” shape would provide more apartments with a waterfront view. This schematic drawing shows the drastic change that would result to the structure and character of the historic building if a portion had been removed as proposed (the project was denied because it did not meet the Standards).

The following work is highlighted to indicate that it represents the particularly complex technical or design aspects of rehabilitation projects and should only be considered after the preservation concerns listed above have been addressed.

Recommended

Alterations/Additions for the New Use

Limiting any new excavations adjacent to historic foundations to avoid undermining the structural stability of the building or adjacent historic buildings. Studies should be done to ascertain potential damage to archeological resources.

Correcting structural deficiencies in preparation for the new use in a manner that preserves the structural system and individual character-defining features.

Designing and installing new mechanical or electrical systems when required for the new use which minimize the number of cutouts or holes in structural members.

Adding a new floor when required for the new use if such an alteration does not damage or destroy the structural system or obscure, damage, or destroy character-defining spaces, features, or finishes.

Creating an atrium or a light well to provide natural light when required for the new use in a manner that assures the preservation of the structural system as well as character-defining interior spaces, features, and finishes.

Not Recommended

Carrying out excavations or regrading adjacent to or within a historic building which could cause the historic foundation to settle, shift, or fail; could have a similar effect on adjacent historic buildings; or could destroy significant archeological resources.

Radically changing interior spaces or damaging or destroying features or finishes that are character-defining while trying to correct structural deficiencies in preparation for the new use.

Installing new mechanical and electrical systems or equipment in a manner which results in numerous cuts, splices, or alterations to the structural members.

Inserting a new floor when such a radical change damages a structural system or obscures or destroys interior spaces, features, or finishes.

Inserting new floors or furred-down ceilings which cut across the glazed areas of windows so that the exterior form and appearance of the windows are radically changed.

Damaging the structural system or individual features; or radically changing, damaging, or destroying character-defining interior spaces, features, or finishes in order to create an atrium or a light well.



Building Interior

*Spaces,
Features
and Finishes*

Building Interior

Spaces, Features and Finishes

An interior floor plan, the arrangement and sequence of spaces, and built-in features and applied finishes are individually and collectively important in defining the historic character of the building. Their identification, retention, protection, and repair should be given prime consideration in every rehabilitation project. In evaluating historic interiors prior to rehabilitation, it should be kept in mind that interiors are comprised of a series of primary and secondary spaces. This is applicable to all buildings, from courthouses to cathedrals, to cottages and office buildings. Primary spaces, including entrance halls, parlors, or living rooms, assembly rooms and lobbies, are defined not only by their features and finishes, but by the size and proportion of the rooms themselves—purposely

created to be the visual attraction or functioning “core” of the building. Care should be taken to retain the essential proportions of primary interior spaces and not to damage, obscure, or destroy distinctive features and finishes.

Secondary spaces include areas and rooms that “service” the primary spaces and may include kitchens, bathrooms, mail rooms, utility spaces, hallways, firestairs and work spaces in a commercial or office building. Extensive changes can often be made in these less important areas without having a detrimental effect on the overall historic character.





Recommended

Interior Spaces

Identify, retain and preserve

Identifying, retaining, and preserving a floor plan or interior spaces that are important in defining the overall historic character of the building. This includes the size, configuration, proportion, and relationship of rooms and corridors; the relationship of features to spaces; and the spaces themselves such as lobbies, reception halls, entrance halls, double parlors, theaters, auditoriums, and important industrial or commercial use spaces.



Interior Features and Finishes

Identify, retain and preserve

Identifying, retaining, and preserving interior features and finishes that are important in defining the overall historic character of the building, including columns, cornices, baseboards, fireplaces and mantels, panelling, light fixtures, hardware, and flooring; and wallpaper, plaster, paint, and finishes such as stenciling, marbling, and graining; and other decorative materials that accent interior features and provide color, texture, and patterning to walls, floors, and ceilings.

These photographs suggest the richness and diversity of public building spaces, features, and finishes.

Not Recommended

Radically changing a floor plan or interior spaces—including individual rooms—which are important in defining the overall historic character of the building so that, as a result, the character is diminished.

Altering the floor plan by demolishing principal walls and partitions to create a new appearance.

Altering or destroying interior spaces by inserting floors, cutting through floors, lowering ceilings, or adding or removing walls.

Relocating an interior feature such as a staircase so that the historic relationship between features and space is altered.

Removing or radically changing features and finishes which are important in defining the overall historic character of the building so that, as a result, the character is diminished.

Installing new decorative material that obscures or damages character-defining interior features or finishes.

Removing paint, plaster, or other finishes from historically finished surfaces to create a new appearance (e.g., removing plaster to expose masonry surfaces such as brick walls or a chimney piece).

Applying paint, plaster, or other finishes to surfaces that have been historically unfinished to create a new appearance.

Stripping paint to bare wood rather than repairing or reapplying grained or marbled finishes to features such as doors and panelling.

Radically changing the type of finish or its color, such as painting a previously varnished wood feature.



Photo: Jack E. Boucher, HABS.

This historic character of these 19th century residential interiors was protected and maintained during rehabilitation.

Recommended

Protect and maintain

Protecting and maintaining masonry, wood, and architectural metals which comprise interior features through appropriate surface treatments such as cleaning, rust removal, limited paint removal, and reapplication of protective coating systems.

Protecting interior features and finishes against arson and vandalism before project work begins, erecting protective fencing, boarding-up windows, and installing fire alarm systems that are keyed to local protection agencies.

Protecting interior features such as a staircase, mantel, or decorative finishes and wall coverings against damage during project work by covering them with heavy canvas or plastic sheets.

Installing protective coverings in areas of heavy pedestrian traffic to protect historic features such as wall coverings, parquet flooring and panelling.

Removing damaged or deteriorated paints and finishes to the next sound layer using the gentlest method possible, then repainting or refinishing using compatible paint or other coating systems.

Repainting with colors that are appropriate to the historic building.

Not Recommended

Failing to provide adequate protection to materials on a cyclical basis so that deterioration of interior features results.

Permitting entry into historic buildings through unsecured or broken windows and doors so that the interior features and finishes are damaged by exposure to weather or through vandalism.

Stripping interiors of features such as woodwork, doors, windows, light fixtures, copper piping, radiators; or of decorative materials.

Failing to provide proper protection of interior features and finishes during work so that they are gouged, scratched, dented, or otherwise damaged.

Failing to take new use patterns into consideration so that interior features and finishes are damaged.

Using destructive methods such as propane or butane torches or sandblasting to remove paint or other coatings. These methods can irreversibly damage the historic materials that comprise interior features.

Using new paint colors that are inappropriate to the historic building.

Recommended

Limiting abrasive cleaning methods to certain industrial or warehouse buildings where the interior masonry or plaster features do not have distinguishing design, detailing, tooling, or finishes; and where wood features are not finished, molded, beaded, or worked by hand. Abrasive cleaning should *only* be considered after other, gentler methods have been proven ineffective.

Evaluating the overall condition of materials to determine whether more than protection and maintenance are required, that is, if repairs to interior features and finishes will be necessary.

Furring out exterior walls to add insulation and suspending new ceilings to hide ductwork and wiring can change a room's proportions and can also destroy or obscure significant decorative detailing.



Repair

Repairing interior features and finishes by reinforcing the historic materials. Repair will also generally include the limited replacement in kind—or with compatible substitute material—of those extensively deteriorated or missing parts of repeated features when there are surviving prototypes such as stairs, balustrades, wood panelling, columns; or decorative wall coverings or ornamental tin or plaster ceilings.

Not Recommended

Changing the texture and patina of character-defining features through sandblasting or use of abrasive methods to remove paint, discoloration or plaster. This includes both exposed wood (including structural members) and masonry.

Failing to undertake adequate measures to assure the protection of interior features and finishes.

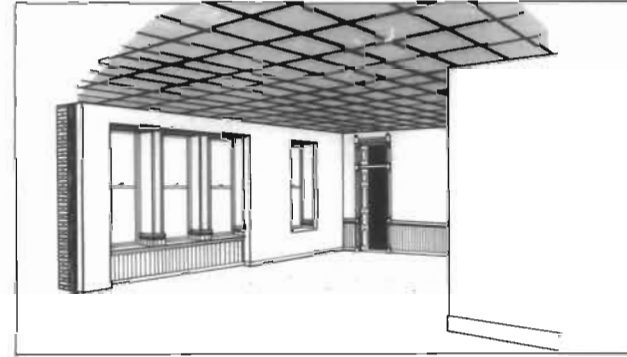

Replacing an entire interior feature such as a staircase, panelled wall, parquet floor, or cornice; or finish such as a decorative wall covering or ceiling when repair of materials and limited replacement of such parts are appropriate.

Using a substitute material for the replacement part that does not convey the visual appearance of the surviving parts or portions of the interior feature or finish or that is physically or chemically incompatible.



Recommended

Replace

Replacing in kind an entire interior feature or finish that is too deteriorated to repair—if the overall form and detailing are still evident—using the physical evidence as a model for reproduction. Examples could include wainscoting, a tin ceiling, or interior stairs. If using the same kind of material is not technically or economically feasible, then a compatible substitute material may be considered.

Before and after: Prior to rehabilitation of this hotel, water intrusion and freeze-thaw cycles had caused extensive efflorescence and plaster failure. The ornamental plaster was almost fully re-manufactured, then gilded. Light fixtures and other detailing were also carefully replicated.



Not Recommended

Removing a character-defining feature or finish that is unreparable and not replacing it; or replacing it with a new feature or finish that does not convey the same visual appearance.

During rehabilitation, the historic plaster was removed from perimeter walls, leaving the brick exposed; in addition historically painted wood trim was stripped. Removing finishes not only destroys historic materials that should be retained and preserved, but it also gives the interior an appearance it never had historically.



The following work is highlighted to indicate that it represents the particularly complex technical or design aspects of rehabilitation projects and should only be considered after the preservation concerns listed above have been addressed.

Recommended

Design for Missing Historic Features

Designing and installing a new interior feature or finish if the historic feature or finish is completely missing. This could include missing partitions, stairs, elevators, lighting fixtures, and wall coverings; or even entire rooms if all historic spaces, features, and finishes are missing or have been destroyed by inappropriate “renovations.” The design may be a restoration based on historical, pictorial, and physical documentation; or be a new design that is compatible with the historic character of the building, district, or neighborhood.

Alterations/Additions for the New Use

Accommodating service functions such as bathrooms, mechanical equipment, and office machines required by the building’s new use in secondary spaces such as first floor service areas or on upper floors.

Reusing decorative material or features that have had to be removed during the rehabilitation work including wall and baseboard trim, door molding, panelled doors, and simple wainscoting; and relocating such material or features in areas appropriate to their historic placement.

Installing permanent partitions in secondary spaces; removable partitions that do not destroy the sense of space should be installed when the new use requires the subdivision of character-defining interior space.

Not Recommended

Creating a false historical appearance because the replaced feature is based on insufficient physical, historical, and pictorial documentation or on information derived from another building.

Introducing a new interior feature or finish that is incompatible with the scale, design, materials, color, and texture of the surviving interior features and finishes.

Dividing rooms, lowering ceilings, and damaging or obscuring character-defining features such as fireplaces, niches, stairways or alcoves, so that a new use can be accommodated in the building.

Discarding historic material when it can be reused within the rehabilitation project or relocating it in historically inappropriate areas.

Installing permanent partitions that damage or obscure character-defining spaces, features, or finishes.

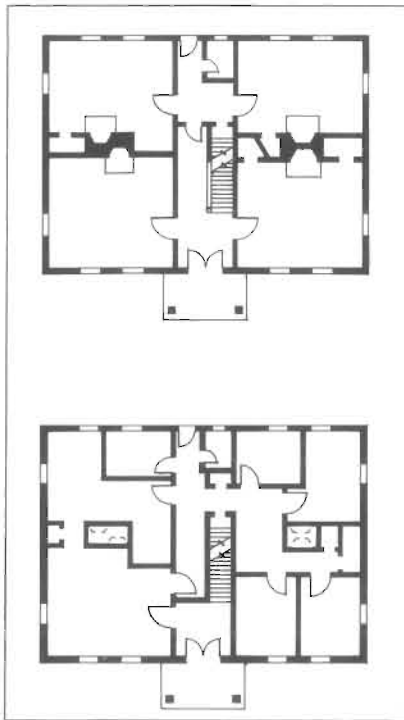

Adding several new rooms to a distinctive interior space may radically change its historic character. Before (top): The original plan was a central hall with four large, equally-sized rooms around it. Each room had a fireplace with a mantel and decorative trim. After (bottom): During rehabilitation, numerous small rooms were added; the open stair was also replaced with a boxed-in stair and the original trim and fireplaces were removed.

Recommended

Alterations/Additions for the New Use

Enclosing an interior stairway where required by code so that its character is retained. In many cases, glazed fire-rated walls may be used.

Placing new code-required stairways or elevators in secondary and service areas of the historic building.

Creating an atrium or a light well to provide natural light when required for the new use in a manner that preserves character-defining interior spaces, features, and finishes as well as the structural system.

Adding a new floor if required for the new use in a manner that preserves character-defining structural features, and interior spaces, features, and finishes.

Not Recommended

Enclosing an interior stairway with fire-rated construction so that the stairwell space or any character-defining features are destroyed.

Radically changing, damaging, or destroying character-defining spaces, features, or finishes when adding new code-required stairways and elevators.

Destroying character-defining interior, spaces, features, or finishes; or damaging the structural system in order to create an atrium or light well.

Inserting a new floor within a building that alters or destroys the fenestration; radically changes a character-defining interior space; or obscures, damages, or destroys decorative detailing.

Building Interior

Mechanical Systems

HEATING

AIR CONDITIONING

ELECTRICAL

AND PLUMBING

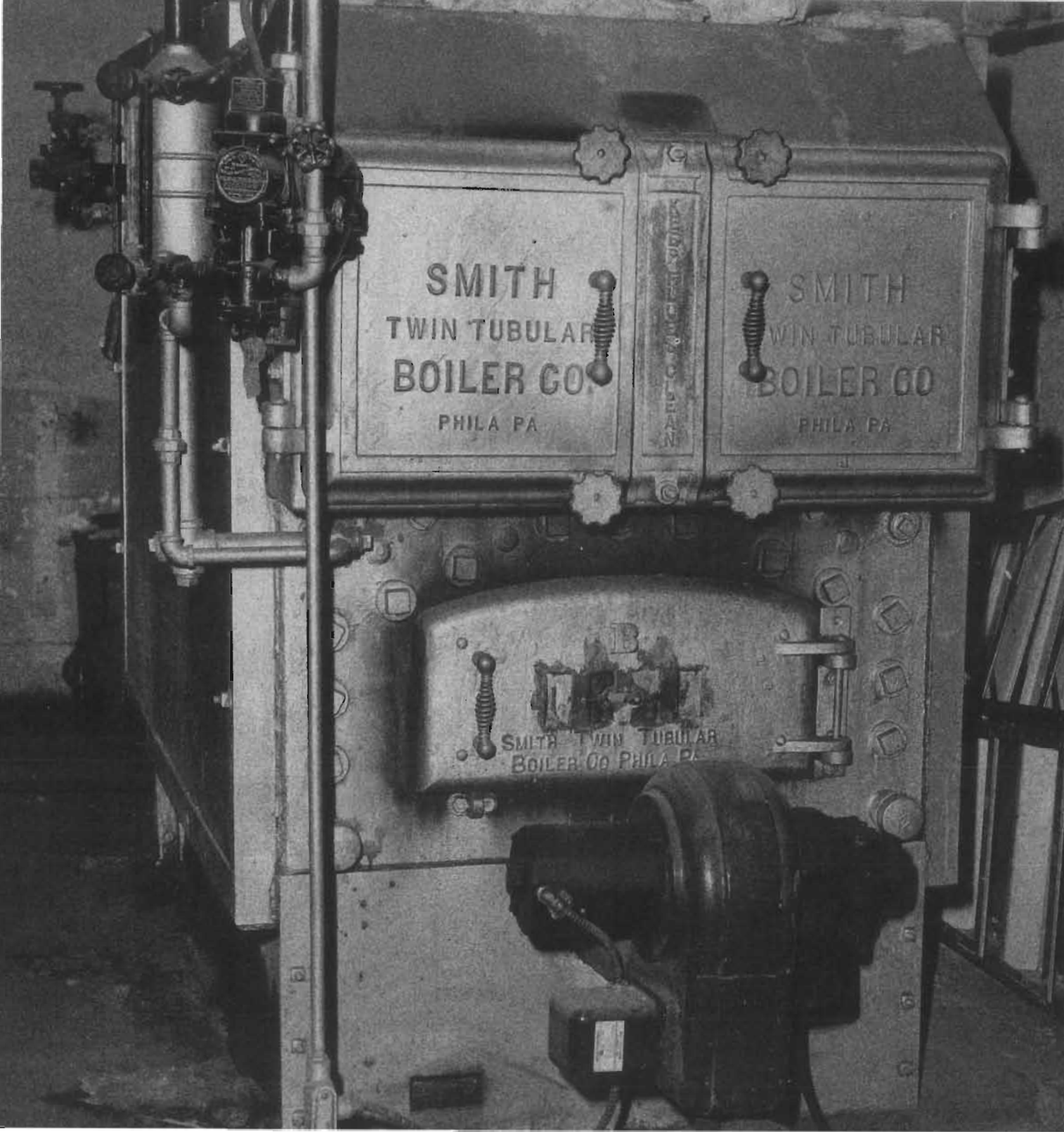

Building Interior

Mechanical Systems

Mechanical, lighting and plumbing systems improved significantly with the coming of the Industrial Revolution. The 19th century interest in hygiene, personal comfort, and the reduction of the spread of disease was met with the development of central heating, piped water, piped gas, and networks of underground cast iron sewers. Vitreous tiles in kitchens, baths and hospitals could be cleaned easily and regularly. The mass production of cast iron radiators made central heating affordable to many; some radiators were elaborate and included special warming chambers for plates or linens. Ornamental grilles and registers provided decorative covers for functional heaters in public spaces. By the turn of the 20th century, it was common to have all of these modern amenities in a building.

The greatest impact of the 20th century on mechanical systems was the use of electricity for interior lighting, forced air ventilation, elevators for tall buildings, exterior lighting and electric heat. The new age of technology brought an increasingly high level

of design and decorative art to the functional elements of mechanical, electrical and plumbing systems.

The visible decorative features of historic mechanical systems such as grilles, lighting fixtures, and ornamental switchplates may contribute to the overall historic character of the building and should thus be retained and repaired, whenever possible. Their identification needs to take place together with an evaluation of their physical condition early in project planning. On the other hand, the functioning parts of many older systems, such as compressors and their ductwork, and wiring and pipes may often need to be upgraded or entirely replaced in order to accommodate the new use and to meet code requirements.

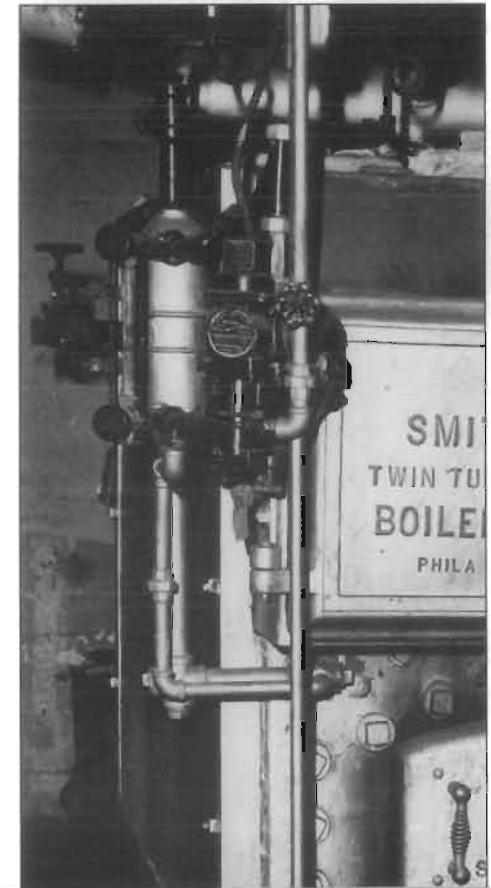



The visible features of historic mechanical systems, such as heating, lighting, and plumbing, may sometimes help define the overall character of an interior.

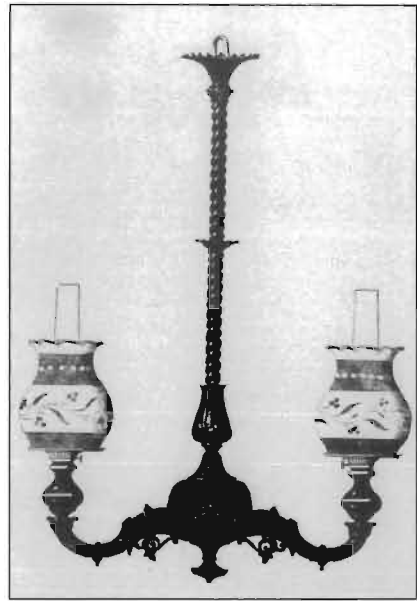

A gaslight may be converted for electrical use to extend its functional and decorative life.

Recommended

Identify, retain and preserve

Identifying, retaining, and preserving visible features of early mechanical systems that are important in defining the overall historic character of the building, such as radiators, vents, fans, grilles, plumbing fixtures, switchplates, and lights.



Photo: Brooks Photographers, HABS Collection.

Protect and maintain

Protecting and maintaining mechanical, plumbing, and electrical systems and their features through cyclical cleaning and other appropriate measures.

Preventing accelerated deterioration of mechanical systems by providing adequate ventilation of attics, crawlspaces, and cellars so that moisture problems are avoided.

Not Recommended

Removing or radically changing features of mechanical systems that are important in defining the overall historic character of the building so that, as a result, the character is diminished.

The bronze elevator doors and light coffers play an important decorative role in this early-20th century administrative building.

Failing to provide adequate protection of materials on a cyclical basis so that deterioration of mechanical systems and their visible features results.

Enclosing mechanical systems in areas that are not adequately ventilated so that deterioration of the systems results.



Both function and design elegance are evident in this row of cast iron elevator cages and light fixtures adorning an early-20th century commercial building.

Recommended

Improving the energy efficiency of existing mechanical systems to help reduce the need for elaborate new equipment. Consideration should be given to installing storm windows, insulating attic crawl space, or adding awnings, if appropriate.

Repair

Repairing mechanical systems by augmenting or upgrading system parts, such as installing new pipes and ducts; rewiring; or adding new compressors or boilers.

Not Recommended

Installing unnecessary air conditioning or climate control systems which can add excessive moisture to the building. This additional moisture can either condense inside, damaging interior surfaces, or pass through interior walls to the exterior, potentially damaging adjacent materials as it migrates.

Replacing a mechanical system or its functional parts when it could be upgraded and retained.

The historic window on a primary facade has been shortened and the area below it filled in with brick in order to install a through-the-wall air conditioning unit. In addition to changing the window size and destroying the sill, the unit itself is visually obtrusive.



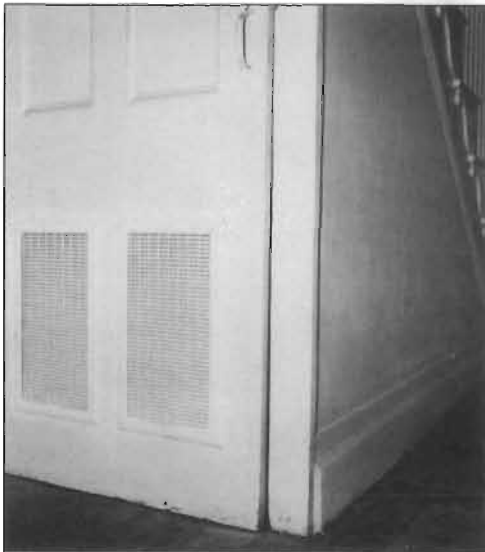
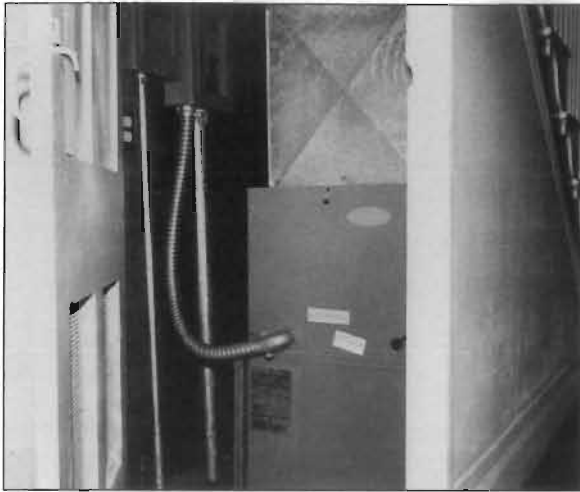

When a late-19th century single-family house was converted to four rental units, the new HVAC system was installed under the central stair. When the door is closed, only the vents indicate its presence.

Recommended

Replace

Replacing in kind—or with compatible substitute material—those visible features of mechanical systems that are either extensively deteriorated or are prototypes such as ceiling fans, switchplates, radiators, grilles, or plumbing fixtures.

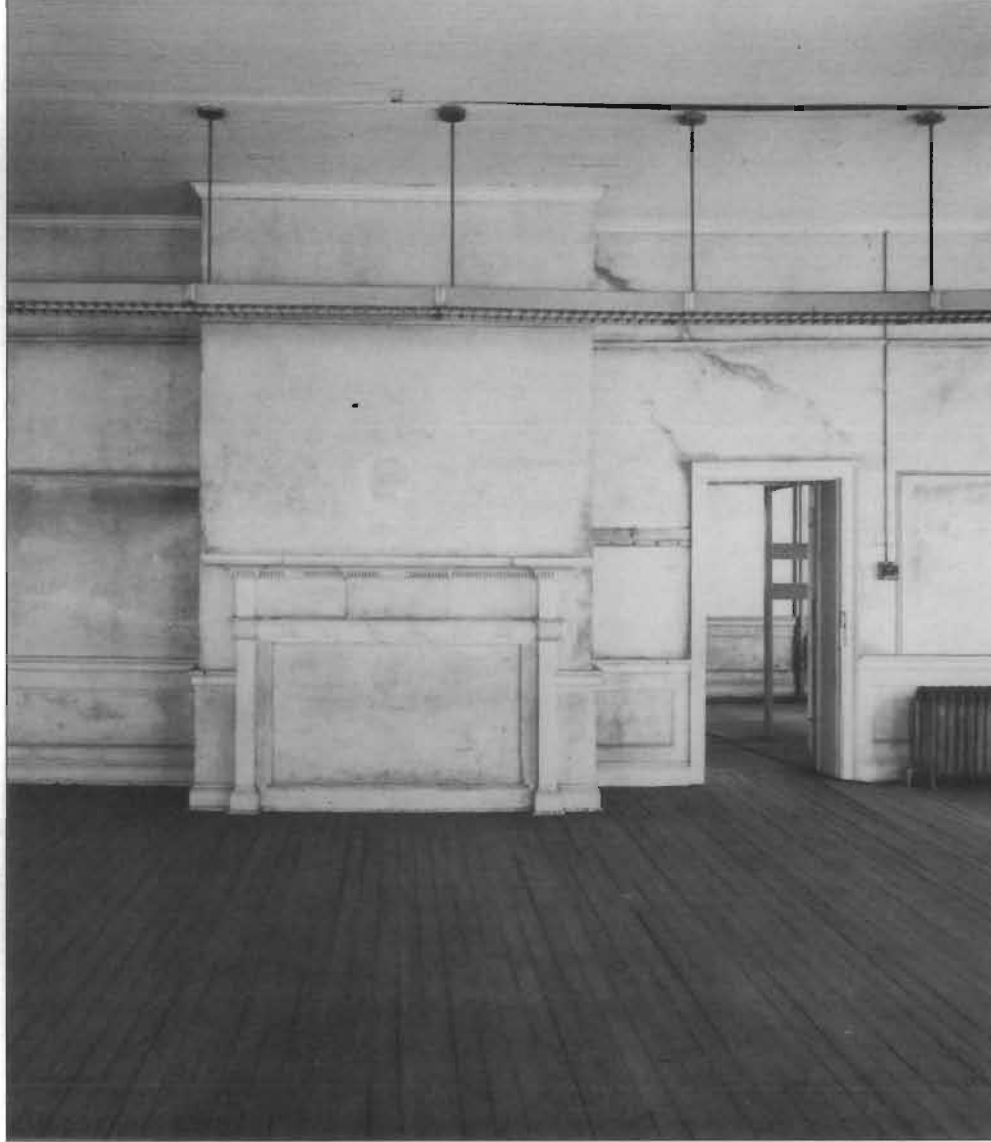

This row of hanging fluorescent lights installed in an earlier renovation mars an otherwise classically detailed interior. They have also caused the historic beaded ceiling to pull away from the joists.

Not Recommended

Installing a replacement feature that does not convey the same visual appearance.

The following work is highlighted to indicate that it represents the particularly complex technical or design aspects of rehabilitation projects and should only be considered after the preservation concerns listed above have been addressed.



Recommended

Alterations/Additions for the New Use

Installing a completely new mechanical system if required for the new use so that it causes the least alteration possible to the building's floor plan, the exterior elevations, and the least damage to the historic building material.

Providing adequate structural support for new mechanical equipment.

Installing the vertical runs of ducts, pipes, and cables in closets, service rooms, and wall cavities.

Installing air conditioning units if required by the new use in such a manner that historic features are not damaged or obscured and excessive moisture is not generated that will accelerate deterioration of historic materials.

Installing heating/air conditioning units in the window frames in such a manner that the sash and frames are protected. Window installations should be considered only when all other viable heating/cooling systems would result in significant damage to historic materials.

Not Recommended

Installing a new mechanical system so that character-defining structural or interior features are radically changed, damaged, or destroyed.

Failing to consider the weight and design of new mechanical equipment so that, as a result, historic structural members or finished surfaces are weakened or cracked.

Installing vertical runs of ducts, pipes, and cables in places where they will obscure character-defining features.

Concealing mechanical equipment in walls or ceilings in a manner that requires the removal of historic building material.

Installing "dropped" acoustical ceiling to hide mechanical equipment when this destroys the proportions of character-defining interior spaces.

Cutting through features such as masonry walls in order to install air conditioning units.

Radically changing the appearance of the historic building or damaging or destroying windows by installing heating/air conditioning units in historic window frames.

Building Site



Building Site

The landscape surrounding a historic building and contained within an individual parcel of land is considered the building site. The site, including its associated features, contributes to the overall character of the historic property. As a result, the relationship between the buildings and landscape features within the site's boundaries should be considered in the overall planning for rehabilitation project work.

Landscapes which contain historic buildings are found in rural, suburban, and urban communities and reflect environmental influences such as climate as well as the historic period in which they were created. Landscapes created for functional purposes as well as aesthetic enjoyment have been a part of American history since European settlement. Historic American styles in landscape design developed from 17th-18th century Spanish and Colonial gardens, evolving into the pastoral and picturesque design of the 19th century. Victorian carpet bedding, popular during the late 19th century, produced profuse plantings of annuals and

perennials. Later, the early 20th century yielded a return to classical traditions, with revival gardens reflecting European renaissance design.

The building site may be significant in its own right, or derive its significance simply from its association with the historic structure. The level of significance, association, integrity, and condition of the building site may influence the degree to which the existing landscape features should be retained during the rehabilitation project. In an industrial property, the site may be defined simply as the relationship between buildings or between the ground plane and open space and its associated buildings. Designed historic landscapes significant in the field of landscape architecture require a more detailed analysis of their character-defining features which may include lawns, hedges, walks, drives, fences, walls, terraces, water features, topography (grading) and furnishings. Vegetation is an important feature in landscapes; this material, including both native species and cultivated

plants, creates an appearance that is constantly changing, both seasonally and annually. Since most plant material is adapted to specific environments, the character of landscapes varies dramatically in different climates, elevations and regions.



Recommended

Identify, retain and preserve

Identifying, retaining, and preserving buildings and their features as well as features of the site that are important in defining its overall historic character. Site features may include circulation systems such as walks, paths, roads, or parking; vegetation such as trees, shrubs, fields, or herbaceous plant material; landforms such as terracing, berms or grading; furnishings such as lights, fences, or benches; decorative elements such as sculpture, statuary or monuments; water features including fountains, streams, pools, or lakes; and subsurface archeological features which are important in defining the history of the site.

Retaining the historic relationship between buildings and the landscape.

The stream and circular wagon approach are important features of this historic mill site.



Not Recommended

Removing or radically changing buildings and their features or site features which are important in defining the overall historic character of the property so that, as a result, the character is diminished.



Photo: Courtesy, Whitman County Historical Society, Inc., Pullman, Washington.

Landscape features that are important in defining the historic character of a building site may include fences, walks, and small outbuildings, as well as trees, bushes and topography that may be unique, such as the hill behind the house.

Removing or relocating buildings or landscape features thus destroying the historic relationship between buildings and the landscape.

Removing or relocating historic buildings on a site or in a complex of related historic structures—such as a mill complex or farm—thus diminishing its historic character.

Moving buildings onto the site, thus creating a false historical appearance.

Radically changing the grade level of the site. For example, changing the grade adjacent to a building to permit development of a formerly below-grade area that would drastically change the historic relationship of the building to its site.

Recommended

Providing proper drainage to assure that water does not erode foundation walls; drain toward the building; or damage or erode the landscape.

Minimizing disturbance of terrain around buildings or elsewhere on the site, thus reducing the possibility of destroying or damaging important landscape features or archeological resources.

Surveying and documenting areas where the terrain will be altered to determine the potential impact to important landscape features or archeological resources.

Not Recommended

Failing to maintain adequate site drainage so that buildings and site features are damaged or destroyed; or alternatively, changing the site grading so that water no longer drains properly.

Introducing heavy machinery into areas where it may disturb or damage important landscape features or archeological resources.

Failing to survey the building site prior to the beginning of rehabilitation work which results in damage to, or destruction of, important landscape features or archeological resources.

Whenever possible, non-destructive techniques should be used to inventory and evaluate archeological resources to ensure their protection.

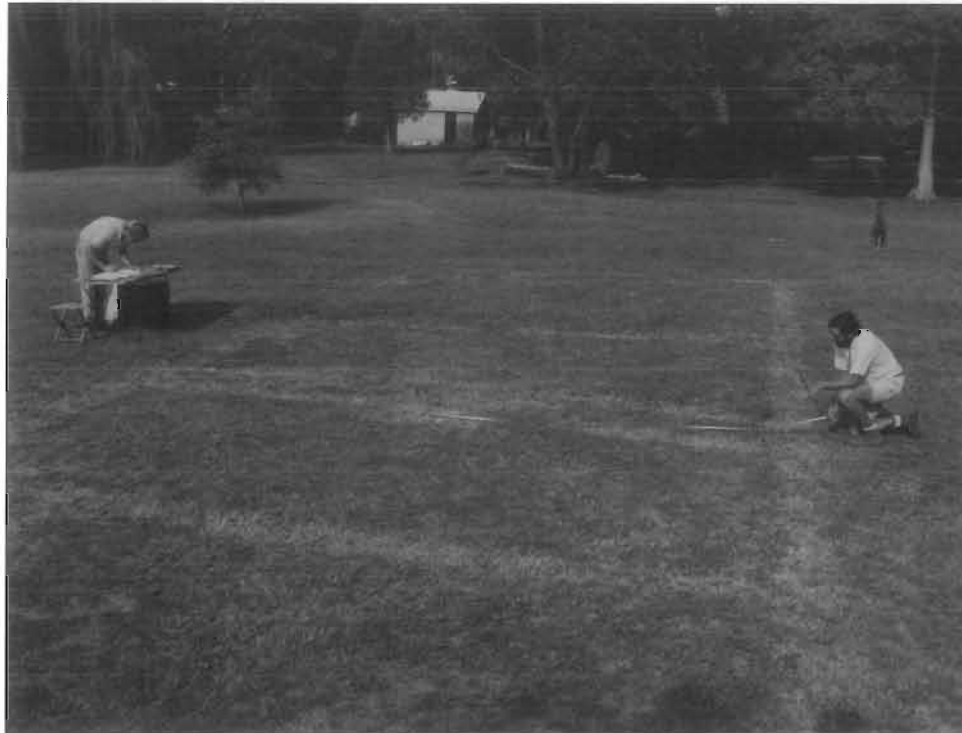

Recommended

Protect and maintain

Protecting, e.g., preserving in place important archeological resources.

Planning and carrying out any necessary investigation using professional archeologists and modern archeological methods when preservation in place is not feasible.

Preserving important landscape features, including ongoing maintenance of historic plant material.

Protecting building and landscape features against arson and vandalism before rehabilitation work begins, i.e., erecting protective fencing and installing alarm systems that are keyed into local protection agencies.



▲► The roof and stained glass windows of this historic church have been appropriately covered with plywood as a protective measure during construction of a new building on an adjacent lot.

Not Recommended

Leaving known archeological material unprotected so that it is damaged during rehabilitation work.

Permitting unqualified personnel to perform data recovery on archeological resources so that improper methodology results in the loss of important archeological material.

Allowing important landscape features to be lost or damaged due to a lack of maintenance.

Permitting the property to remain unprotected so that the building and landscape features or archeological resources are damaged or destroyed.

Removing or destroying features from the building or site such as wood siding, iron fencing, masonry balustrades, or plant material.

Recommended

Providing continued protection of masonry, wood, and architectural metals which comprise the building and site features through appropriate cleaning, rust removal, limited paint removal, and re-application of protective coating systems.

Evaluating the overall condition of materials and features to determine whether more than protection and maintenance are required, that is, if repairs to building and site features will be necessary.

Repair

Repairing features of the building and site by reinforcing historic materials.

Park-like settings surrounding many historic mansions are important in defining their historic character. However, the relationship between building and site was destroyed by an inappropriate rehabilitation when this house was converted into offices, and the formally landscaped grounds in front of the house were bulldozed to provide a parking lot.

Not Recommended

Failing to provide adequate protection of materials on a cyclical basis so that deterioration of building and site features results.

Failing to undertake adequate measures to assure the protection of building and site features.

Replacing an entire feature of the building or site such as a fence, walkway, or driveway when repair of materials and limited compatible replacement of deteriorated or missing parts are appropriate.

Using a substitute material for the replacement part that does not convey the visual appearance of the surviving parts of the building or site feature or that is physically or chemically incompatible.



Recommended

Replace

Replacing in kind an entire feature of the building or site that is too deteriorated to repair if the overall form and detailing are still evident.

Physical evidence from the deteriorated feature should be used as a model to guide the new work. This could include an entrance or porch, walkway, or fountain. If using the same kind of material is not technically or economically feasible, then a compatible substitute material may be considered.

Replacing deteriorated or damaged landscape features in kind.

Not Recommended

Removing a feature of the building or site that is unrepairable and not replacing it; or replacing it with a new feature that does not convey the same visual appearance.

Adding conjectural landscape features to the site such as period reproduction lamps, fences, fountains, or vegetation that is historically inappropriate, thus creating a false sense of historic development.



Photo: Library, The State Historical Society of Colorado

This wood picket fence is as important to the site as the shutters, porch detailing, and clapboards are to the house. As such, the fence was carefully repaired and painted as part of an overall project to preserve the historic residence.

The following work is highlighted to indicate that it represents the particularly complex technical or design aspects of rehabilitation project work and should only be considered after the preservation concerns listed above have been addressed.

Recommended

Design for Missing Historic Features

Designing and constructing a new feature of a building or site when the historic feature is completely missing, such as an outbuilding, terrace or driveway. It may be based on historical, pictorial, and physical documentation; or be a new design that is compatible with the historic character of the building and site.

Alterations/Additions for the New Use

Designing new onsite parking, loading docks, or ramps when required by the new use so that they are as unobtrusive as possible and assure the preservation of the historic relationship between the building or buildings and the landscape.

Designing new exterior additions to historic buildings or adjacent new construction which is compatible with the historic character of the site and which preserves the historic relationship between the building or buildings and the landscape.

Removing nonsignificant buildings, additions, or site features which detract from the historic character of the site.

Not Recommended

Creating a false historical appearance because the replaced feature is based on insufficient historical, pictorial, and physical documentation.

Introducing a new building or site feature that is out of scale or of an otherwise inappropriate design.

Introducing a new landscape feature, including plant material, that is visually incompatible with the site, or that alters or destroys the historic site patterns or vistas.

Locating any new construction on the building where important landscape features will be damaged or destroyed, for example removing a lawn and walkway and installing a parking lot.

Placing parking facilities directly adjacent to historic buildings where automobiles may cause damage to the buildings or to important landscape features.

Introducing new construction onto the building site which is visually incompatible in terms of size, scale, design, materials, color, and texture; which destroys historic relationships on the site; or which damages or destroys important landscape features.

Removing a historic building in a complex of buildings; or removing a building feature, or a landscape feature which is important in defining the historic character of the site.

Setting

*District or
Neighborhood*



Setting

District or Neighborhood

The setting is the area or environment in which a historic property is found. It may be an urban or suburban neighborhood or a natural landscape in which a building has been constructed. The elements of setting, such as the relationship of buildings to each other, setbacks, fence patterns, views, driveways and walkways, and street trees together create the character of a district or neighborhood. In some instances, many individual building sites may form a neighborhood or setting. In rural environments, agricultural or natural landscapes may form the setting for an individual property.





In an urban historic district, the alignment and width of roads, the relationship between buildings and yards, and the repetition of trees lining the streets help define its historic character.



The setting is an important aspect of a historic district. In a rural historic district, the natural topography and landscape features, agricultural field patterns, roads, and the organization of buildings and structures all contribute to its character.

Recommended

Identify, retain and preserve

Identifying, retaining, and preserving building and landscape features which are important in defining the historic character of the setting. Such features can include roads and streets, furnishings such as lights or benches, vegetation, gardens and yards, adjacent open space such as fields, parks, commons or woodlands, and important views or visual relationships.

Retaining the historic relationship between buildings and landscape features of the setting. For example, preserving the relationship between a town common and its adjacent historic houses, municipal buildings, historic roads, and landscape features.

Protect and maintain

Protecting and maintaining historic building materials and plant features through appropriate treatments such as cleaning, rust removal, limited paint removal, and reapplication of protective coating systems; and pruning and vegetation management.

Protecting buildings and landscape features against arson and vandalism before rehabilitation work begins by erecting protective fencing and installing alarm systems that are keyed into local protection agencies.

Not Recommended

Removing or radically changing those features of the setting which are important in defining the historic character.

Destroying the relationship between the buildings and landscape features within the setting by widening existing streets, changing landscape materials or constructing inappropriately located new streets or parking.

Removing or relocating historic buildings or landscape features, thus destroying their historic relationship within the setting.

Failing to provide adequate protection of materials on a cyclical basis which results in the deterioration of building and landscape features.

Permitting the building and setting to remain unprotected so that interior or exterior features are damaged.

Stripping or removing features from buildings or the setting such as wood siding, iron fencing, terra cotta balusters, or plant material.

Recommended

Evaluating the overall condition of the building and landscape features to determine whether more than protection and maintenance are required, that is, if repairs to features will be necessary.

Street furniture such as this historic clock helps define an urban district's character and thus should be retained in a rehabilitation.



Photo: Jack E. Boucher, HABS.

Repair

Repairing features of the building and landscape by reinforcing the historic materials. Repair will also generally include the replacement in kind—or with a compatible substitute material—of those extensively deteriorated or missing parts of features where there are surviving prototypes such as porch balustrades or paving materials.

Not Recommended

Failing to undertake adequate measures to assure the protection of building and landscape features.

Cast Iron Benches, Illustrated Catalogue of Ornamental Iron Works, Janes, Kirtland & Co., 1870. Benches can be important features both in defining an urban streetscape as well as a more rural landscape.

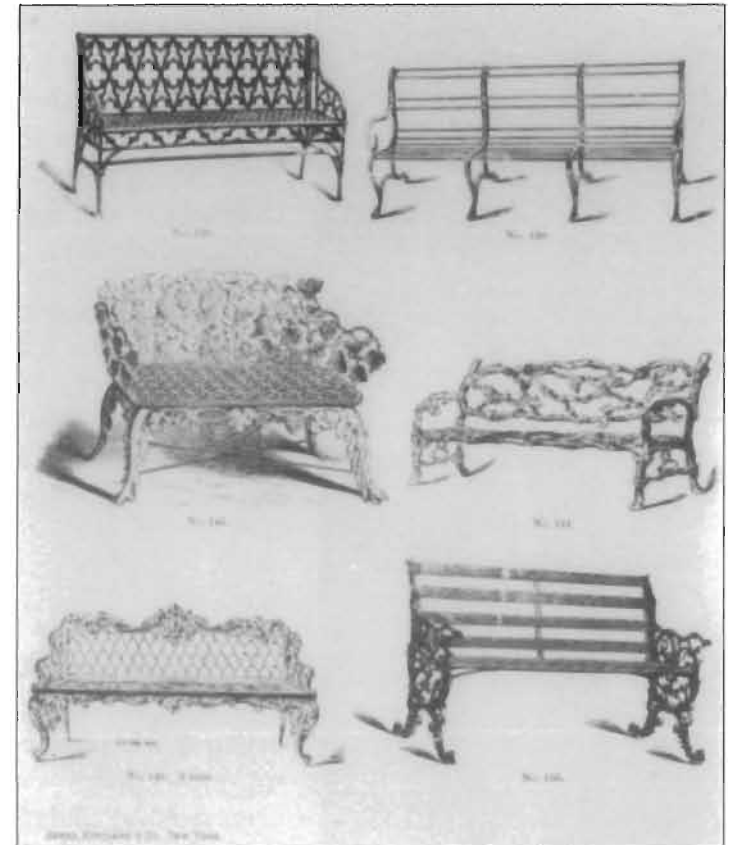

Replacing an entire feature of the building or landscape when repair of materials and limited replacement of deteriorated or missing parts are appropriate.

Using a substitute material for the replacement part that does not convey the visual appearance of the surviving parts of the building or landscape, or that is physically, chemically, or ecologically incompatible.

This late-19th century residential historic district is characterized by brick row-houses with two-storied bays. A streetscape's visual continuity can be marred by an insensitive rehabilitation such as the one shown here. The original two-story brick bay of one of the houses was removed and replaced with a three-story bay that is incompatible in size, materials, and detailing.



Recommended

Replace

Replacing in kind an entire feature of the building or landscape that is too deteriorated to repair — when the overall form and detailing are still evident — using the physical evidence as a model to guide the new work. If using the same kind of material is not technically or economically feasible, then a compatible substitute material may be considered.



Not Recommended

Removing a feature of the building or landscape that is unrepairable and not replacing it; or replacing it with a new feature that does not convey the same visual appearance.

The following work is highlighted because it represents the particularly complex technical or design aspects of rehabilitation projects and should only be considered after the preservation concerns above have been addressed.

Recommended

Design for Missing Historic Features

Designing and constructing a new feature of the building or landscape when the historic feature is completely missing, such as rowhouse steps, a porch, a streetlight, or terrace. It may be a restoration based on documentary or physical evidence; or be a new design that is compatible with the historic character of the setting.

Alterations/Additions for the New Use

Designing required new parking so that it is as unobtrusive as possible, thus minimizing the effect on the historic character of the setting. “Shared” parking should also be planned so that several businesses can utilize one parking area as opposed to introducing random, multiple lots.

Designing and constructing new additions to historic buildings when required by the new use. New work should be compatible with the historic character of the setting in terms of size, scale, design, material, color, and texture.

Removing nonsignificant buildings, additions or landscape features which detract from the historic character of the setting.

Not Recommended

Creating a false historical appearance because the replaced feature is based on insufficient documentary or physical evidence.

Introducing a new building or landscape feature that is out of scale or otherwise inappropriate to the setting’s historic character, e.g., replacing picket fencing with chain link fencing.

Placing parking facilities directly adjacent to historic buildings which cause damage to historic landscape features, including removal of plant material, relocation of paths and walkways, or blocking of alleys.

Introducing new construction into historic districts that is visually incompatible or that destroys historic relationships within the setting.

Removing a historic building, building feature, or landscape feature that is important in defining the historic character of the setting.

Although the work in the following sections is quite often an important aspect of rehabilitation projects, it is usually *not* part of the overall process of preserving character-defining features (maintenance, repair, replacement); rather, such work is assessed for its potential negative impact on the building's historic character. For this reason, particular care must be taken not to obscure, radically change, damage, or destroy character-defining features in the process of rehabilitation work.



Energy Conservation

Energy Conservation

Some character-defining features of a historic building or site such as cupolas, shutters, transoms, skylights, sun rooms, porches, and plantings also play a secondary, energy-conserving role. Therefore, prior to retrofitting historic buildings to make them more energy efficient, the first step should always be to identify and evaluate the existing historic features to assess their inherent energy-conserving potential. If it is determined that retrofitting measures are necessary, then such work needs to be carried out with particular care to insure that the building's historic character is preserved in the process of rehabilitation.



Recommended

District/Neighborhood

Maintaining those existing landscape features which moderate the effects of the climate on the setting such as deciduous trees, evergreen wind-blocks, and lakes or ponds.

Building Site

Retaining plant materials, trees, and landscape features, especially those which perform passive solar energy functions such as sun shading and wind breaks.

Installing freestanding solar collectors in a manner that preserves the historic property's character-defining features.

Designing attached solar collectors, including solar greenhouses, so that the character-defining features of the property are preserved.

Masonry/Wood/Architectural Metals

Installing thermal insulation in attics and in unheated cellars and crawlspaces to increase the efficiency of the existing mechanical systems.

Installing insulating material on the inside of masonry walls to increase energy efficiency where there is no character-defining interior molding around the window or other interior architectural detailing.

Not Recommended

Stripping the setting of landscape features and landforms so that the effects of the wind, rain, and the sun results in accelerated deterioration of historic materials.

Removing plant materials, trees, and landscape features, so that they no longer perform passive solar energy functions.

Installing freestanding solar collectors that obscure, damage, or destroy historic landscape or archeological features.

Locating solar collectors where they radically change the property's appearance; or damage or destroy character-defining features.

Applying thermal insulation with a high moisture content into wall cavities in an attempt to reduce energy consumption.

Resurfacing historic building materials with more energy efficient but incompatible materials, such as covering historic masonry with exterior insulation.

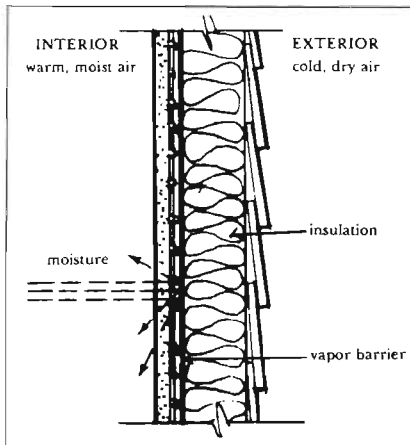

When installing insulation in the wall cavity of a historic wood-frame building, a vapor barrier must be placed facing-in toward the heated side of the wall. The vapor barrier prevents moisture from passing from the warm interior to the cold exterior, thus keeping the insulation and adjacent building materials dry.

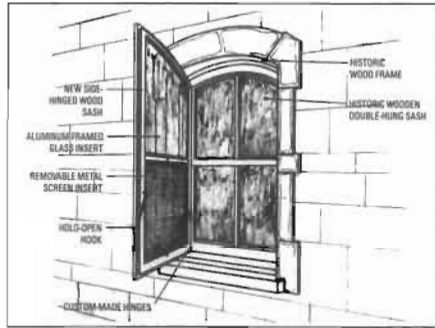

Historic residential window—*appropriate storm window retrofit*. The single casement, wooden storm window has two removable panels for screen and glass inserts. It is designed to minimize visual changes to the historic building.

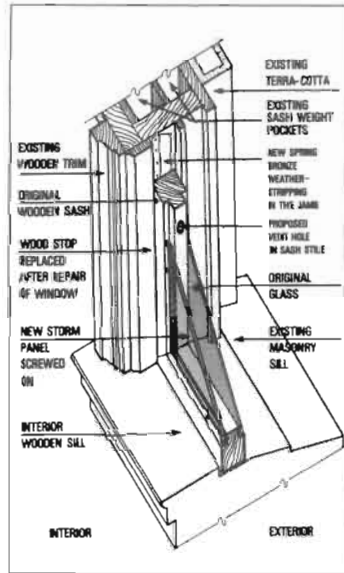

Historic commercial window—*appropriate storm window retrofit*. This cutaway view shows how the historic sash would receive a recessed storm panel through routing or cutting an inside rabbet.

Recommended

Installing passive solar devices such as a glazed “trombe” wall on a rear or inconspicuous side of the historic building.

Roofs

Placing solar collectors on non-character-defining roofs or roofs of nonhistoric adjacent buildings.

Windows

Utilizing the inherent energy conserving features of a building by maintaining windows and louvered blinds in good operable condition for natural ventilation.

Improving thermal efficiency with weatherstripping, storm windows, caulking, interior shades, and if historically appropriate, blinds and awnings.

Installing interior storm windows with air-tight gaskets, ventilating holes, and/or removable clips to insure proper maintenance and to avoid condensation damage to historic windows.

Installing exterior storm windows which do not damage or obscure the windows and frames.

Not Recommended

Installing passive solar devices such as an attached glazed “trombe” wall on primary or other highly visible elevations; or where historic material must be removed or obscured.

Placing solar collectors on roofs when such collectors change the historic roofline or obscure the relationship of the roof features such as dormers, skylights, and chimneys.

Removing historic shading devices rather than keeping them in an operable condition.

Replacing historic multi-paned sash with new thermal sash utilizing false muntins.

Installing interior storm windows that allow moisture to accumulate and damage the window.

Installing new exterior storm windows which are inappropriate in size or color.

Replacing windows or transoms with fixed thermal glazing or permitting windows and transoms to remain inoperable rather than utilizing them for their energy conserving potential.

Recommended

Considering the use of lightly tinted glazing on non-character-defining elevations if other energy retrofit alternatives are not possible.

Not Recommended

Using tinted or reflective glazing on character-defining or other conspicuous elevations.

Entrances and Porches

Utilizing the inherent energy conserving features of a building by maintaining porches and double vestibule entrances in good condition so that they can retain heat or block the sun and provide natural ventilation.

Enclosing porches located on character-defining elevations to create passive solar collectors or airlock vestibules. Such enclosures can destroy the historic appearance of the building.



In hot climates, buildings were historically designed to minimize the heat gain from the summer sun. The wide roof overhangs, exterior porches, shutters, shade trees, and heavy masonry walls (painted white) are all energy saving characteristics.

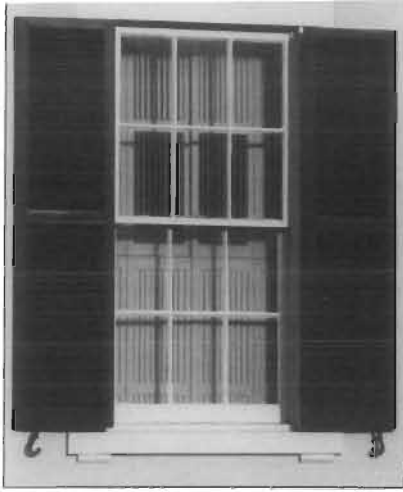

Shutters were used to minimize temperature extremes. If interior or exterior shutters are present, they should be retained, preserved, and used as they were historically.

Recommended

Interior Features

Retaining historic interior shutters and transoms for their inherent energy conserving features.

New Additions to Historic Buildings

Placing new additions that have an energy conserving function such as a solar greenhouse on non-character-defining elevations.

Mechanical Systems

Improving energy efficiency of existing mechanical systems by installing insulation in attics and basements.

Not Recommended

Removing historic interior features which play a secondary energy conserving role.

Installing new additions such as multi-story solar greenhouse additions which obscure, damage, or destroy character-defining features.

Replacing existing mechanical systems that could be repaired for continued use.

This decorative cast-iron vent serves a useful passive energy conservation function by allowing air to circulate at basement level.

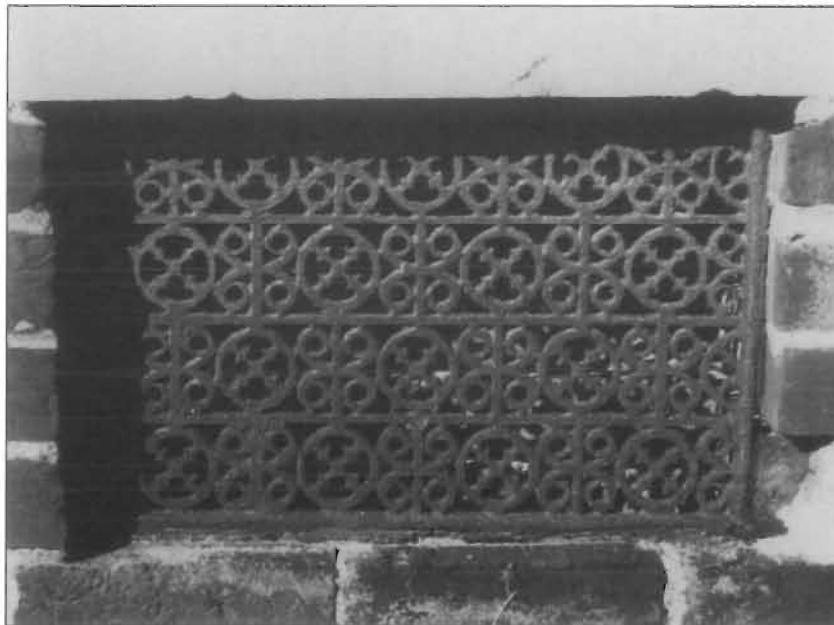



New
Additions
to Historic
Buildings

New Additions to Historic Buildings

An attached exterior addition to a historic building expands its “outer limits” to create a new profile. Because such expansion has the capability to radically change the historic appearance, an exterior addition should be considered only after it has been determined that the new use cannot be successfully met by altering non-character-defining interior spaces. If the new use cannot be met in this way, then an attached exterior addition is usually an acceptable alternative. New additions should be designed and constructed so that the character-defining features of the historic building are not radically changed, obscured, damaged, or destroyed in the process of rehabilitation. New design should always be clearly differentiated so that the addition does not appear to be part of the historic resource.





Recommended

Placing functions and services required for the new use in non-character-defining interior spaces rather than constructing a new addition.

Constructing a new addition so that there is the least possible loss of historic materials and so that character-defining features are not obscured, damaged, or destroyed.

Locating the attached exterior addition at the rear or on an inconspicuous side of a historic building; and limiting its size and scale in relationship to the historic building.

Designing new additions in a manner that makes clear what is historic and what is new.

Not Recommended

Expanding the size of the historic building by constructing a new addition when the new use could be met by altering non-character-defining interior spaces.

Attaching a new addition so that the character-defining features of the historic building are obscured, damaged, or destroyed.

Designing a new addition so that its size and scale in relation to the historic building are out of proportion, thus diminishing the historic character.

Duplicating the exact form, material, style, and detailing of the historic building in the new addition so that the new work appears to be part of the historic building.

Imitating a historic style or period of architecture in new additions, especially for contemporary uses such as drive-in banks or garages.

An 1847 residence was successfully converted into a bank, with the construction of a low-scale addition. The drawing shows how the three-unit addition has been stepped down the hill, each unit set further back from the historic structure as it extends horizontally. As a result, the new addition is only partially visible from the historic "approach." The small connector was sensitively designed to minimize loss of historic building materials.

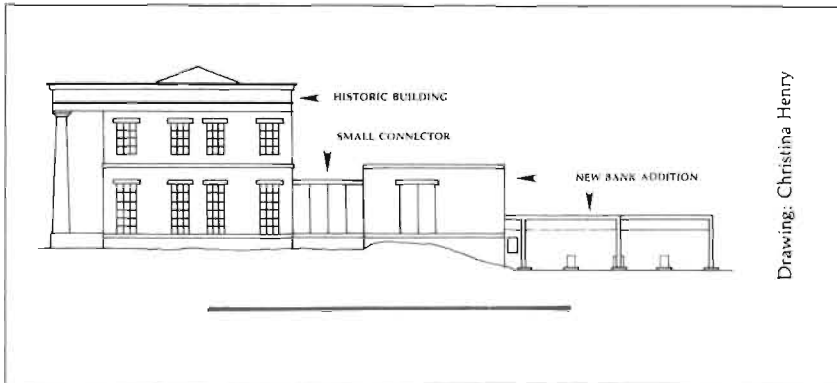

A new 10-story wing added to the back of a historic library constitutes major expansion, yet is compatible because it reads as a subsidiary unit to the much larger historic building.



Left: This rooftop addition has substantially altered the historic profile and proportions of a three-story row house; more important, it has interrupted the uniform roof height of the block. The greenhouse is also a jarring element in an otherwise intact 19th century streetscape. Below: A sizeable employee lounge was added atop this four-story historic commercial building. Because the rooftop addition has been set back from both the front and side roof edges against a party wall, the historic character of the building and the district have been preserved.



Recommended

Considering the attached exterior addition both in terms of the new use and the appearance of other buildings in the historic district or neighborhood. Design for the new work may be contemporary or may reference design motifs from the historic building. In either case, it should always be clearly differentiated from the historic building and be compatible in terms of mass, materials, relationship of solids to voids, and color.

Not Recommended

Designing and constructing new additions that result in the diminution or loss of the historic character of the resource, including its design, materials, workmanship, location, or setting.

Using the same wall plane, roof line, cornice height, materials, siding lap or window type to make additions appear to be a part of the historic building.



Recommended

Placing new additions such as balconies and greenhouses on non-character-defining elevations and limiting the size and scale in relationship to the historic building.

Designing additional stories, when required for the new use, that are set back from the wall plane and are as inconspicuous as possible when viewed from the street.

The historic residence is on the right. By copying the decorative gable and three-part window in the new addition, the old and new portions are virtually indistinguishable. This approach violates the Standards for Rehabilitation.

Not Recommended

Designing new additions such as multi-story greenhouse additions that obscure, damage, or destroy character-defining features of the historic building.

Constructing additional stories so that the historic appearance of the building is radically changed.



In rehabilitating a historic bank for a new use, a small restaurant addition was built on the rear. The new addition is compatible with the historic building primarily because of its scale and location.



Two small Victorian cottages, above, were connected to provide additional floor space in a commercial rehabilitation. The inappropriate infill connector, below, is on the same plane as the historic facades, essentially making the two cottages appear as one building. If the new infill had been substantially set back from the facade, the distinct form of each cottage would have been retained.

Accessibility Considerations



Accessibility Considerations

It is often necessary to make modifications to a historic property so that it can comply with current accessibility code requirements. Accessibility to certain historic buildings and sites is required by three specific federal laws: the Architectural Barriers Act of 1968, Section 504 of the Rehabilitation Act of 1973, and the Americans with Disabilities Act of 1990. Federal rules, regulations, and standards have been developed which provide guidance on how to accomplish access in historic areas. The question is not *if* access should be provided; the question is *how* to provide

it to meet both accessibility *and* historic preservation requirements. Thus, work must be carefully planned and undertaken so that it does not result in a loss of character-defining spaces, features, and finishes. The goal is to provide the highest level of access with the lowest level of impact.



Recommended

Identifying the historic building's character defining spaces, features, and finishes so that accessibility code-required work will not result in their damage or loss.

Complying with barrier-free access requirements, in such a manner that character-defining spaces, features, and finishes are preserved.

Not Recommended

Undertaking code-required alterations before identifying those spaces, features or finishes which are character-defining and must therefore be preserved.

Altering, damaging, or destroying character-defining features in attempting to comply with accessibility requirements.



The historic cast iron railing was preserved when a permanent ramp was designed for this museum's main entrance.

Access to this rural historic site has been improved to include designated parking areas, properly graded ramps and walkways around the site, and access within the building to all services.

Photo: Cuyahoga Valley National Recreation Area, NPS.



Recommended

Working with local disability groups, access specialists, and historic preservation specialists to determine the most appropriate solution to access problems.

Providing barrier-free access that promotes independence for the disabled person to the highest degree practicable, while preserving significant historic features.

Designing new or additional means of access that are compatible with the historic property and its setting.

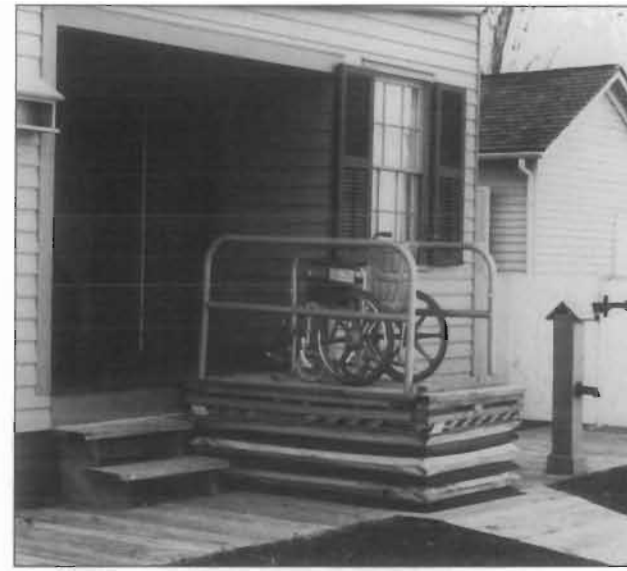

An accordion-type platform lift that retracts to ground level when not in use has been installed to make this historic house accessible.

Not Recommended

Making changes to buildings without first seeking expert advice from access specialists and historic preservationists, to determine solutions.

Providing access modifications that do not provide a reasonable balance between independent, safe access and preservation of historic features.

Designing new or additional means of access without considering the impact on the historic property and its setting.

A relatively simple way to increase accessibility inside a historic building may be to add bevels to the sides of a threshold.

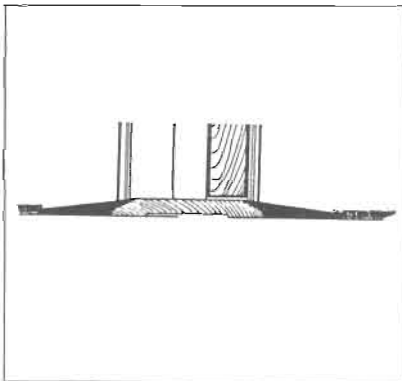

Drawing: Duncan S. Ballantyne.



Health and Safety Considerations

Health and Safety Considerations

In undertaking rehabilitation work on historic buildings, it is necessary to consider the impact that meeting current health and safety codes (public health, occupational health, life safety, fire safety, electrical, structural and building codes) will have on character-defining spaces, features, and finishes. Special coordination with the responsible code officials at the state, county or municipal level may be required. Securing required building permits and occupancy licenses is best accomplished early in rehabilitation planning.

In the area of occupational health, research on older, more commonly used building materials (insulation, floor and wall coverings and lead paints) indicates that the presence of toxic substances in them is potentially hazardous to building occupants. Following careful investigation and analysis, some form of abatement may be required such as encapsulation, or partial or total removal. All workers involved in the encapsulation, repair, or removal of known toxic materials should be adequately trained and

should wear proper personal protective equipment. Finally, preventive and routine maintenance programs for historic structures known to contain such materials should also be developed to include proper warnings and precautions.



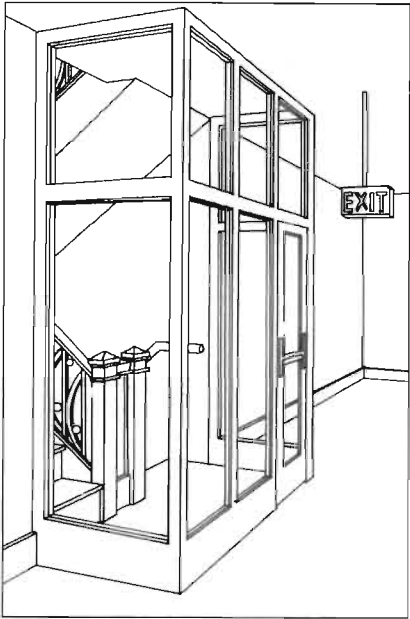

Existing decorative staircases in historic buildings may meet safety requirements if enclosed with safety glass. This enclosure preserves the stairs while providing a secure means of egress.

Recommended

Identifying the historic building's character-defining spaces, features, and finishes so that code-required work will not result in their damage or loss.

Complying with health and safety codes, including seismic code requirements, in such a manner that character-defining spaces, features, and finishes are preserved.

Removing toxic building materials only after thorough testing has been conducted and only after less invasive abatement methods have been shown to be inadequate.

Providing workers with appropriate personal protective equipment for hazards found in the worksite.

Working with local code officials to investigate systems, methods, or devices of equivalent or superior effectiveness and safety to those prescribed by code so that unnecessary alterations can be avoided.

Upgrading historic stairways and elevators to meet health and safety codes in a manner that assures their preservation, i.e., so that they are not damaged or obscured.

Not Recommended

Undertaking code-required alterations to a building or site before identifying those spaces, features, or finishes which are character-defining and must therefore be preserved.

Altering, damaging, or destroying character-defining spaces, features, and finishes while making modifications to a building or site to comply with safety codes.

Destroying historic interior features and finishes without careful testing and without considering less invasive abatement methods.

Removing unhealthful building materials without regard to personal and environmental safety.

Making changes to historic buildings without first exploring equivalent health and safety systems, methods, or devices that may be less damaging to historic spaces, features, and finishes.

Damaging or obscuring historic stairways and elevators or altering adjacent spaces in the process of doing work to meet code requirements.

A sprinkler system has been sensitively installed in this highly ornamental plaster ceiling during the building's rehabilitation. Sprinkler heads have been unobtrusively located in the center of the decorative plaster relief.



Recommended

Installing sensitively designed fire suppression systems, such as sprinkler systems that result in retention of historic features and finishes.

Applying fire-retardant coatings, such as intumescent paints, which expand during fire to add thermal protection to steel.

Not Recommended

Covering character-defining wood features with fire-resistant sheathing which results in altering their visual appearance.

Using fire-retardant coatings if they damage or obscure character-defining features.

Recommended

Adding a new stairway or elevator to meet health and safety codes in a manner that preserves adjacent character-defining features and spaces.

Placing a code-required stairway or elevator that cannot be accommodated within the historic building in a new exterior addition. Such an addition should be on an inconspicuous elevation.



In order to comply with safety codes, it may be necessary to add an exterior fire stair to a historic building as part of a rehabilitation project. The brick stairtower shown on the top is compatible in materials and scale, and inconspicuously attached to the rear elevation of the historic rowhouse. The example on the bottom shows a large-scale concrete and glass stairtower that is incompatible in materials and scale, located as it is on a highly visible elevation of the historic brick building.

In buildings such as this historic courthouse, where old lead-based paint is essentially intact and covered with a lead-free topcoat, removing the historic paint because of potential toxicity may not be necessary. Historic paint can provide valuable documentation about the evolution of a building and should be retained, whenever possible.

Not Recommended

Radically changing, damaging, or destroying character-defining spaces, features, or finishes when adding a new code-required stairway or elevator.

Constructing a new addition to accommodate code-required stairs and elevators on character-defining elevations highly visible from the street; or where it obscures, damages, or destroys character-defining features.

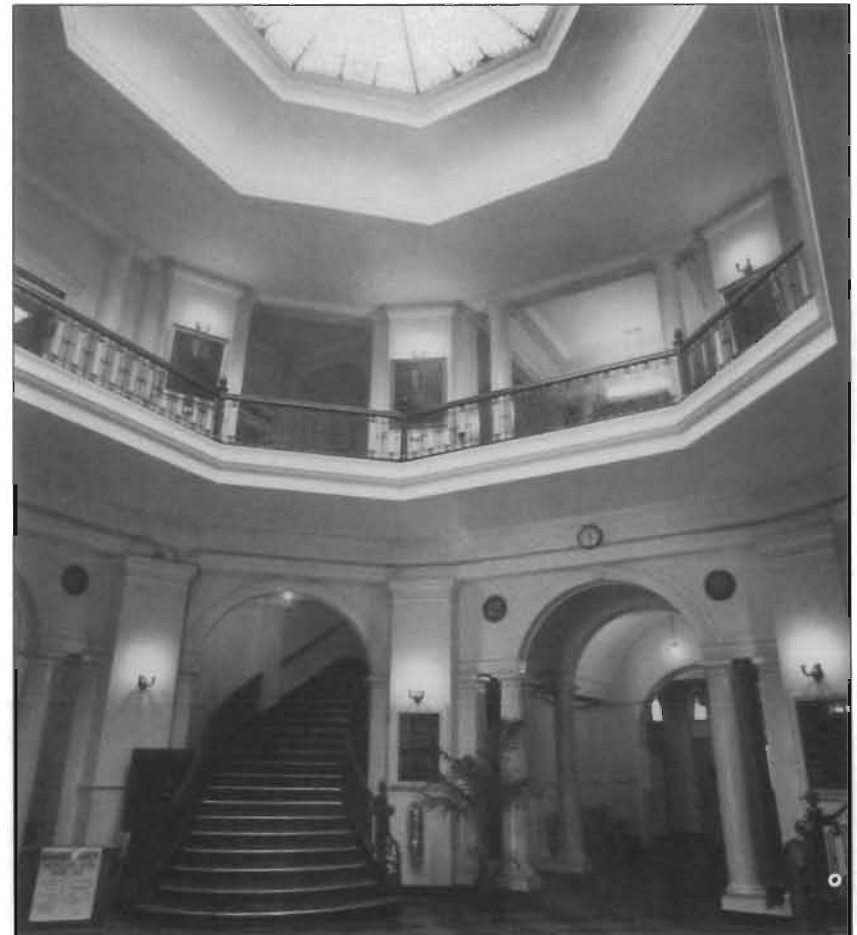

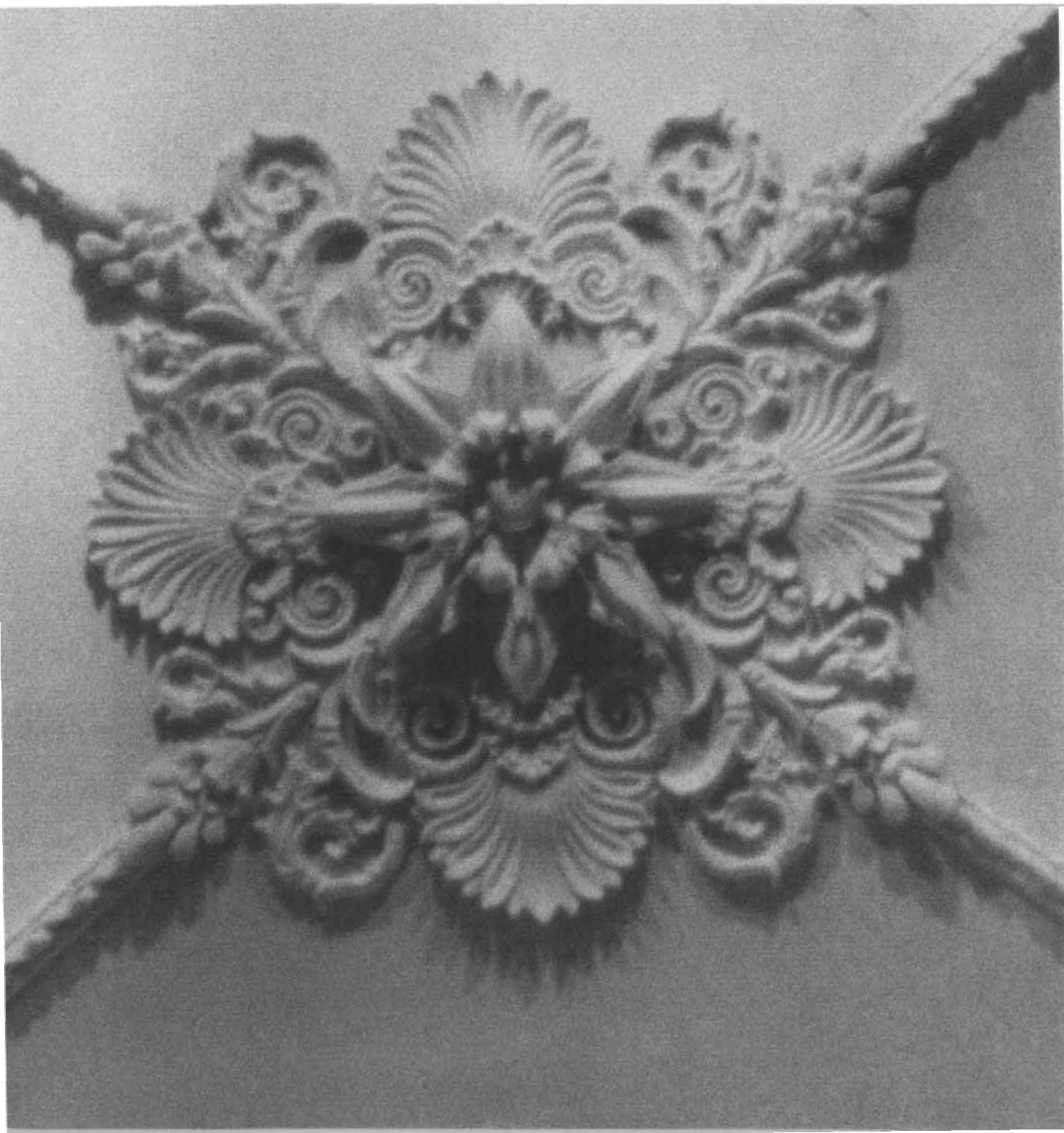

Technical
Guidance
Publications

Technical Guidance Publications

For a free copy of the TPS catalog
of historic preservation publications,
write:

Heritage Preservation Services (2255)
Technical Preservation Services
National Park Service
1849 C Street NW,
Washington, D.C. 20240.



GATE FASTENINGS

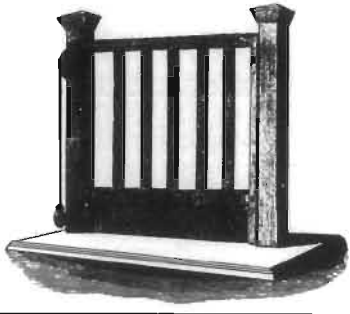

Program/Training Information

Federal Historic Preservation Laws. Sara K. Blumenthal, Ed. Lists the major historic preservation laws that govern a national program to coordinate and support public and private efforts to identify, evaluate, and protect our historic and archeological resources. 59 pages. 1990.

Interpreting the Secretary of the Interior's Standards for Rehabilitation. Michael J. Auer, Ed. Explains how the National Park Service applies the Standards in its administration of the historic preservation tax incentives program. 33 project bulletins. 150 illustrations. 1988.

Preservation Tax Incentives for Historic Buildings. Explains Federal tax incentives available to owners who rehabilitate commercial historic structures. Includes an outline of the certification process, program regulations, and a list of State Historic Preservation Officers. 24 pages. Revised 1990.

Preservation Briefs

Preservation Briefs assist owners and developers of historic buildings in recognizing and resolving common preservation and repair problems prior to work. The briefs are especially useful to preservation tax incentive program applicants because they recommend those methods and approaches for rehabilitating historic buildings that are consistent with their historic character.

Preservation Briefs 1: The Cleaning and Waterproof Coating of Masonry Buildings. Robert C. Mack, AIA. Provides guidance on cleaning and waterproofing techniques and explains the consequences of their inappropriate use. 4 pages. 5 illustrations. 1975.

Preservation Briefs 2: Repointing Mortar Joints in Historic Brick Buildings. Robert C. Mack, AIA, de Teel Paterson Tiller, and James S. Askins. Provides information on appropriate materials and methods for repointing historic brick buildings. 8 pages. 12 illustrations. 1980.

Preservation Briefs 3: Conserving Energy in Historic Buildings. Baird M. Smith, AIA. Provides information on materials and techniques to consider or avoid when undertaking weatherization and energy conservation measures in historic buildings. 8 pages. 8 illustrations. 1978.

Preservation Briefs 4: Roofing for Historic Buildings. Sarah M. Sweetser. Provides a brief history of the most commonly used roofing materials in America. Presents a sound preservation approach to roof repair, roof replacement, and the use of alternative roofing materials. 8 pages. 16 illustrations. 1978.

Preservation Briefs 5: The Preservation of Historic Adobe Buildings. Provides information on the traditional materials and construc-

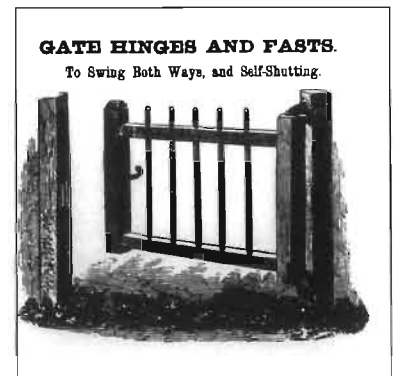

tion of adobe buildings, and the causes of adobe deterioration. Makes recommendations for preserving historic adobe buildings. 8 pages. 15 illustrations. 1978.

Preservation Briefs 6: Dangers of Abrasive Cleaning to Historic Buildings. Anne E. Grimmer. Cautions against the use of sandblasting to clean various building materials and suggests measures to mitigate the effects of improper cleaning. Explains the limited circumstances under which abrasive cleaning may be appropriate. 8 pages. 10 illustrations. 1979.

Preservation Briefs 7: The Preservation of Historic Glazed Architectural Terra-Cotta. de Teel Patterson Tiller. Discusses deterioration problems that commonly occur with terra-cotta and provides methods for determining the extent of such deterioration. Makes recommendations for maintenance and repair, and suggests appropriate replacement materials. 8 pages. 11 illustrations. 1979.

Preservation Briefs 8: Aluminum and Vinyl Siding on Historic Buildings: The Appropriateness of Substitute Materials for Resurfacing Historic Wood Frame Buildings. John H. Myers, revised by Gary L. Hume. Discusses various types of historic wood siding and repair and replacement in kind. Outlines the instances under which substitute siding may be an acceptable alternative. 7 pages. 5 illustrations. Rev, 1984.

Preservation Briefs 9: The Repair of Historic Wooden Windows. John H. Myers. Provides

useful information on evaluating and repairing historic wooden windows found in typical rehabilitation projects. Emphasizes practical methods for homeowners or developers. 8 pages. 10 illustrations. 1981.

Preservation Briefs 10. Exterior Paint Problems on Historic Woodwork. Kay D. Weeks and David W. Look, AIA. Identifies and describes common types of paint surface conditions and failures. Provides guidance on preparing historic woodwork for repainting, including limited and total paint removal. 12 pages. 14 illustrations. 1982.

Preservation Briefs 11. Rehabilitating Historic Storefronts. H. Ward Jandl. Explores the role of the storefront in historic buildings and provides guidance on rehabilitation techniques for historic storefronts as well as compatible new storefront designs. 12 pages. 12 illustrations. 1982.

Preservation Briefs 12. The Preservation of Historic Pigmented Structural Glass (Vitrolite and Carrara Glass). Provides information on the early manufacture, installation, and use of this decorative building product commonly found in 20th century buildings; reasons for its damage; and a general approach for its maintenance, repair, and replacement. 8 pages. 16 illustrations. 1984.

Preservation Briefs 13. The Repair and Thermal Upgrading of Historic Steel Windows. Sharon C. Park, AIA. Presents brief historical background on the development, use, and styles of rolled steel windows popular in the first half

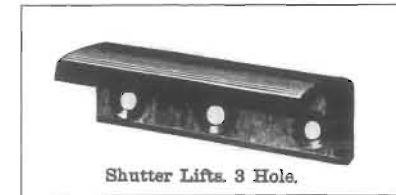
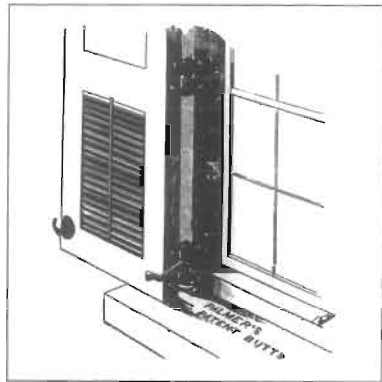

of the 20th century. Explains steps for cleaning and repairing damaged steel windows; also provides information on appropriate methods of weatherstripping and options for storm panels or the installation of thermal glass. 12 pages. 10 illustrations. 1984.

Preservation Briefs 14: New Exterior Additions to Historic Buildings: Preservation Concerns. Kay D. Weeks. Uses a series of examples to suggest ways that attached new additions can successfully serve contemporary uses as part of a rehabilitation project while preserving significant historic materials and features and the building's historic character. 12 pages. 30 illustrations. 1986.

Preservation Briefs 15: Preservation of Historic Concrete: Problems and General Approaches. William B. Coney, AIA. Focuses on cast-in-place and reinforced concrete. The guidance addresses the causes of concrete deterioration, the signs of deterioration, and actual concrete repair. 12 pages. 27 illustrations. 1987.

Preservation Briefs 16: The Use of Substitute Materials on Historic Building Exteriors. Sharon C. Park, AIA. Includes a discussion of when to use substitute materials, cautions regarding their expected performance, and descriptions of several substitute materials together with their advantages and disadvantages. Summary charts are included. 14 pages. 34 illustrations. 1988.

Preservation Briefs 17: Architectural Character—Identifying the Visual Aspects of Historic

Buildings as an Aid to Preserving Their Character. Lee H. Nelson, FAIA. Essential guidance to help property owners and architects identify those features of historic buildings that give the building its visual character so that their preservation can be maximized in rehabilitation. 12 pages. 27 illustrations. 1988.

Preservation Briefs 18: Rehabilitating Interiors in Historic Buildings—Identifying Character-Defining Elements. H. Ward Jandl. Assists building owners in identifying significant interior spaces, features, and finishes so they may be preserved in rehabilitation work. The guidance applies to all building types and styles, from 18th century churches to 20th century office buildings. 8 pages. 11 illustrations. 1988.

Preservation Briefs 19: The Repair and Replacement of Historic Wooden Shingle Roofs. Sharon C. Park, AIA. Discusses historic wooden roofing, expectations for longevity, and repair and replacement options. Identifies roofing material that duplicates the appearance of a historic roof, offers guidance on proper installation, and provides information on coatings and maintenance procedures to help preserve the new roof. 12 pages. 16 illustrations. 1989.

Preservation Briefs 20: The Preservation of Historic Barns. Michael J. Auer. Identifies historic barn types, helps owners understand the historic character of their barns, and offers advice on the maintenance, repair, and rehabilitation of old and historic barns. 12 pages. 30 illustrations. 1989.



Photo: Richard Nickel, HABS

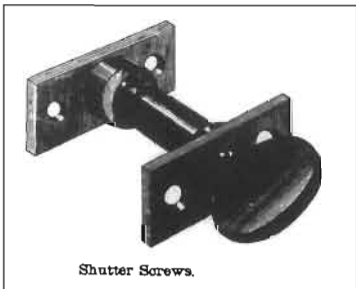

Shutter Screws.

Preservation Briefs 21: Repairing Historic Flat Plaster—Walls and Ceilings. Marylee MacDonald. Guides building owners on repairing historic plaster using traditional materials and techniques. Suggests replacement options if the historic plaster is severely deteriorated. Useful chart on various plaster bases and compatible basecoats and finish coats. 14 pages. 17 illustrations. 1989.

Preservation Briefs 22: The Preservation and Repair of Historic Stucco. Anne E. Grimmer. Describes the evolution of stucco as a popular building material, beginning with a brief history of how stucco is applied, and how its composition, texture, and surface patterns have changed. Includes guidelines for the historic property owner or manager on repairing historic stucco, with sample mixes for 18th, 19th, and 20th century stucco types. 16 pages. 33 illustrations. 1990.

Preservation Briefs 23: Preserving Historic Ornamental Plaster. David Flaharty. Explains the processes of run-in-place and cast ornamentation by using three common decorative forms as examples: the cornice, ceiling medallion, and coffered ceiling. Illustrates common causes of plaster deterioration and repair techniques. Useful advice on selecting and evaluating a restoration contractor is included. 14 pages. 34 illustrations. 1990.

Preservation Briefs 24: Heating, Ventilating, and Cooling Historic Buildings: Problems and Recommended Approaches. Sharon C. Park, AIA. Outlines the history of mechanical systems

from the 18th c. to the early 20th c. Discusses issues involving occupant comfort and climate control. Underscores the importance of careful planning in order to balance preservation objectives with the interior climate needs of historic buildings. Useful chart included that gives an overview of contemporary HVAC systems together with advantages and disadvantages. 12 pages. 17 illustrations. September, 1991.

Preservation Briefs 25: The Preservation of Historic Signs. Michael J. Auer. Reviews sign types and practices from the 18th c. to the 1960's. Discusses the complex issues involved in repairing and re-using historic signs for contemporary businesses. 12 pages. 30 illustrations. September, 1991.

Preservation Briefs 26: The preservation and Repair of Historic Log Buildings. Bruce D. Bomberger. Reviews and illustrates historic log construction from the 18th c. to the early 20th c., focusing on horizontally-laid logs. Discusses traditional splicing-in techniques, the use of epoxies, and log replacement, as well as guidance on the repair and replacement of chinking and daubing. 16 pages. 25 illustrations. September, 1991.

Preservation Briefs 27: The Maintenance and Repair of Architectural Cast Iron. John G. Waite, AIA. Historical Overview by Margot Gayle. Discusses cast iron in terms of 19th century industrial development. Emphasizes the importance of this versatile material in architectural building design, technology, and ornamentation. Provides essential guidance on maintain-

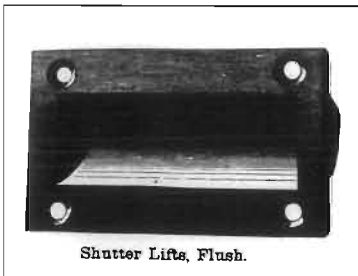
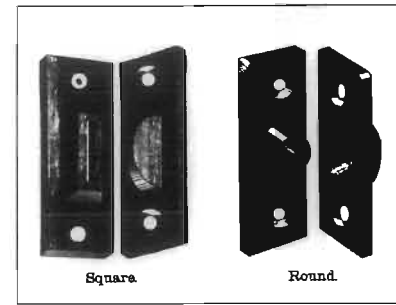

Shutter Lifts, Flush.

ing and repairing architectural cast iron within rehabilitation projects. 14 pages. 25 illustrations. September, 1991.

Technical Reports

Technical Reports address in detail problems confronted by architects, engineers, government officials, and other technicians involved in the preservation of historic buildings.

A Glossary of Historic Masonry Deterioration Problems and Preservation Treatments. Anne E. Grimmer. Generously illustrated, provides information on 22 common masonry deterioration problems and their known treatments. Intended for use both as a general reference tool and an on-site interpretive guide in the maintenance and preservation of historic structures. 68 pages. 41 illustrations. 1984. Bibliography.

Access to Historic Buildings for the Disabled: Suggestions for Planning and Implementation. Charles Parrott. Describes methods to achieve barrier-free access to historic buildings that conform with the Department of the Interior's historic preservation standards. Addresses a variety of specific needs for the disabled, including ramps, vertical wheelchair lifts, curb cuts, railings, restrooms, miscellaneous fixtures, and signs. Also examines techniques to make programs and services housed in historic buildings accessible in lieu of architectural changes. 92 pages. 42 illustrations. 1980. Bibliography.

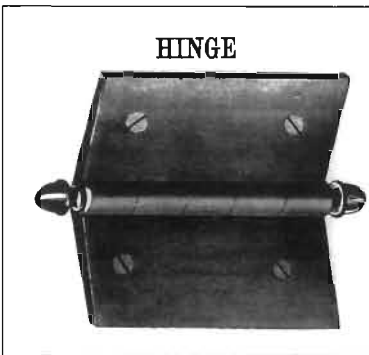

Cyclical Maintenance for Historic Buildings. J. Henry Chambers, AIA. Provides a step-by-step process for building managers, architects, and others involved in the routine maintenance of historic properties. 125 pages. 1976. Bibliography.

Epoxies for Wood Repairs in Historic Buildings. Morgan W. Phillips and Dr. Judith E. Selwyn. Presents research findings on the use of epoxies to preserve historic wood features rather than replacing them. Discusses low-viscosity epoxy consolidants that can be soaked into rotted wood in order to restore its solidity; and epoxy pastes for filling holes and cracks in historic woodwork. Includes useful case-study applications, suggested formulations, and lists of suppliers. 72 pages. 43 illustrations. Appendix. 1978.

Gaslighting in America: A Pictorial Survey, 1815-1910. Denys Peter Myers. Surveys the types and style of gas fixtures that appeared in the rooms and on the streets of 19th and early 20th century America. 279 pages. 120 illustrations. Originally published by the National Park Service in 1978, re-issued by Dover Press, New York, in 1990.

Keeping it Clean: Removing Dirt, Paint, Stains, and Graffiti from Historic Exterior Masonry. Anne E. Grimmer. Covers virtually every aspect of a cleaning project—identifying building materials to be cleaned and ones that might be affected by cleaning; scheduling cleaning around other work; what to ask for in cleaning “specs;” and what kind of test cleaning procedures to use. Useful chart summarizes

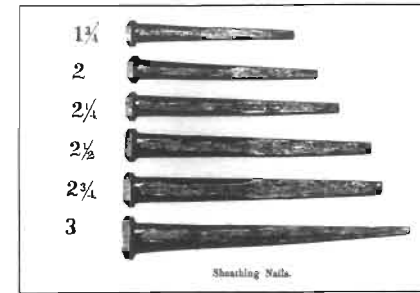

cleaners and removal techniques. 45 pages. 35 illustrations. Bibliography.

Metals in America's Historic Buildings: Uses and Preservation Treatments. Margot Gayle and David W. Look, AIA. One of the most complete sourcebooks available on historic architectural metals, such as lead, tin, zinc, bronze, copper, iron, nickel, steel and aluminum. Part 1 focuses on the identification and historic uses of architectural metals; Part 2 provides in-depth information on repair and preservation methods, discussing each metal individually. 168 pages. 180 illustrations. Bibliography. 1980.

Moisture Problems in Historic Masonry Walls: Diagnosis and Treatment. Baird M. Smith, AIA. Intended for architects, building owners, property managers, and others responsible for the care and maintenance of historic buildings. Discusses problems caused by excessive moisture in historic masonry walls and outlines a methodology for diagnosing such problems and selecting appropriate treatments. 48 pages. 32 illustrations. 1984. Bibliography.

Moving Historic Buildings. John Obed Curtis. Discusses the limited circumstances under which a historic masonry or frame building should be moved. Establishes a methodology for planning, research, and recording prior to the move; and addresses the siting, foundation construction, building reassembly, and restoration work after a successful move has taken place. 50 pages. 47 illustrations. Bibliography.

Photogrammetric Recording of Cultural Resources. Perry E. Borchers. Describes the basic principles of photogrammetry and their application to the recording of cultural resources. Includes several case study applications. 38 pages. 27 illustrations. Bibliography. 1977.

Rectified Photography and Photo Drawings for Historic Preservation. J. Henry Chambers, AIA. Explains the process of making photographic negatives of a predetermined size or scale which can be enlarged to a convenient architectural scale, then printed on photosensitive drafting film for working drawings, surveys, and feasibility studies. 38 pages. 13 illustrations. 1973.

Using Photogrammetry to Monitor Materials Deterioration and Structural Problems on Historic Buildings: Dorchester Heights Monument, A Case Study. J. Henry Chambers, AIA. Details the cost-effectiveness of close-range photogrammetry in monitoring the condition of historic masonry structures, particularly when more conventional methods of inspection are impracticable. 16 pages. 6 illustrations. Bibliography. 1985.

X-Ray Examination of Historic Structures. David M. Hart. Explains a method for nondestructive probing of historic buildings that permits investigation of components normally hidden from view. Intended for architects, conservators, and other professionals. 24 pages. 19 illustrations. Bibliography. 1975.



Patent Fire Hydrant.



Photo: Jack E. Boucher, HAB5

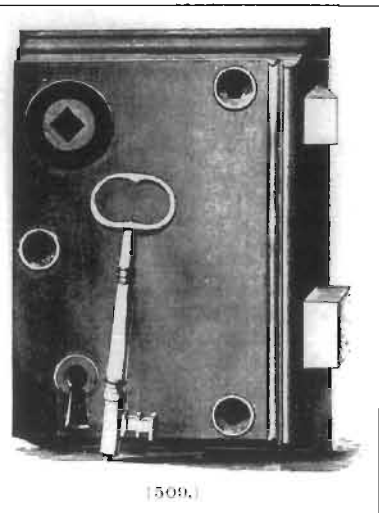

Preservation Case Studies

Preservation Case Studies provide practical, solution-oriented information for developers, planners, and owners by presenting and illustrating a specific course of action taken to preserve one building or an entire block of buildings. Individual case studies may highlight an innovative rehabilitation technique, financing strategies, or an overall planning methodology.

Abbeville, South Carolina: Rehabilitation Planning and Project Work the Commercial Town Square. John M. Bryan and the Triad Architectural Associates. Excellent planning guide for historic building owners interested in rehabilitating an entire block to enhance local commercial trade. Uses a series of architectural drawings and sketches, recommends preservation work for each building inventoried as well as the urban setting. 55 pages. 24 illustrations. 1979.

Fort Johnson, Amsterdam, New York: A Historic Structure Report. Mendel-Mesick-Cohen. From an on-site inspection conducted in 1974-1975, shows steps to take prior to undertaking preservation or restoration work on a historic building. Documents the current state of the building's exterior and interior materials and overall structural stability. Recommends work that meets the Department of Interior's historic preservation standards. Archeological report included. 54 pages. 89 illustrations. Appendices. 1978.

Main Street Historic District, Van Buren, Arkansas: Storefront Rehabilitation/Restoration Within a Districtwide Plan. Susan Guthrie. Illustrates in detail how storefronts in a small town's commercial center were successfully rehabilitated. Emphasizes both planning and rehabilitation by inclusion of working drawings, and before, during and after photographs. 31 pages. 30 illustrations. 1980.

Maymont Park-The Italian Garden, Richmond, Virginia: Landscape Restoration. Barry W. Starke, ASLA. Outlines step-by-step process of conducting historical research on a National Register-listed park, preparing existing conditions documentation, and recommending project work. Includes the landscape architect's drawings and specifications to restore stone walls, garden walkways, and domed pergola according to Department of the Interior historic preservation standards. 39 pages. 29 illustrations. 1980.

Planning for exterior Work on the First Parish Church, Portland, Maine, Using Photographs as Project Documentation. John C. Hecker, AIA, and Sylvanus W. Doughty. Using annotated photographs detailing physical damage and deterioration of a specific church building, shows how project work recommendations were made. Useful methodology for owners and developers planning rehabilitation work on any building. Includes architectural specifications for several work areas, such as site improvements, mortar, brick masonry, rough carpentry, slate roofing, dampproofing,

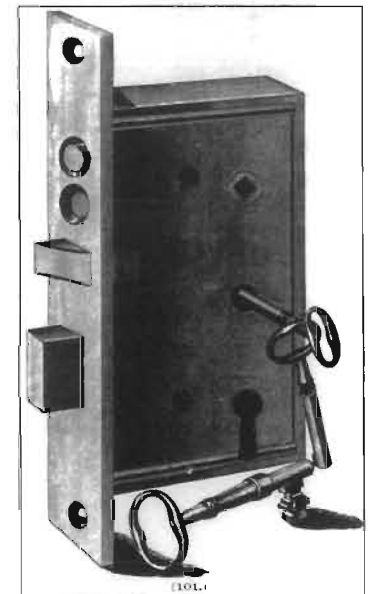

flashing, and painting. 58 pages. 15 illustrations. Secretary of the Interior's Standards as Appendix. 1979.

Olmsted Park System, Jamaica Pond Boathouse, Jamaica Plain, Massachusetts: Planning for the Preservation of the Boathouse Roof.

Richard White. Focuses on planning the preservation of a specific public park building, but useful for planning an entire project to meet Department of Interior historic preservation standards. Presents a responsible process of documenting proposed work, including a brief history of the site and building, evaluation of deterioration, architectural drawings, and a summary of successful completed work. 58 pages. 25 illustrations. Appendix. 1979.

Rehabilitating Historic Hotels: Peabody Hotel, Memphis, Tennessee. Floy A. Brown. Explains use of the preservation tax credit to rehabilitate an important downtown hotel. Outlines the success of other hotel rehabilitations across the United States, then focuses on the Peabody Hotel in Memphis. The case study describes the Peabody's architectural importance, the scope of rehabilitation work, and the funding initiative. 44 pages. 21 illustrations. Appendix. 1979.

The Morse-Libby Mansion: A Report on Restoration Work, 1973-1977. Morgan W. Phillips. Describes and illustrates preservation methods and techniques used in the exterior restoration of an Italianate mansion. 55 pages. 84 illustrations. Appendices. 1977.

Preservation Tech Notes

Preservation Tech Notes (PTN) provide innovative solutions to specific problems in preserving cultural resources—buildings, structures, and objects. Tech Notes are intended for practitioners in the preservation field, including architects, contractors, and maintenance personnel, as well as for owners and developers seeking the preservation tax investment credit for rehabilitation. Topic categories for this series to date include doors, windows, finishes, interior spaces, mechanical systems, museum collection storage, temporary protection, exterior woodwork, masonry, and metals.

PTN 1 Windows(1): Planning Approaches to Window Preservation by Charles E. Fisher. January, 1984.

PTN 2 Windows(2): Installing Insulating Glass in Existing Steel Windows by Charles E. Fisher. January, 1984.

PTN 3 Windows(3): Exterior Storm Windows: Casement Design Wooden Storm Sash by Wayne Trissler and Charles E. Fisher. January, 1984.

PTN 4 Windows(4): Replacement Wooden Frames and Sash: Protecting Woodwork Against Decay by William C. Feist. January, 1984.

PTN 5 Windows(5): Interior Metal Storm Windows by Laura A. Muckenfuss and Charles E. Fisher. January, 1984.



Photo: Jack E. Boucher, HABS



PTN 6 Windows(6): Replacement Wooden Sash and Frames with Insulating Glass and Integral Muntins by Charles Parrott. January, 1984.

PTN 7 Windows(7): Window Awnings by Laura A. Muckenfuss and Charles E. Fisher. September, 1984.

PTN 8 Windows(8): Thermal Retrofit of Historic Wooden Sash Using Interior Piggy-back Storm Panels by Sharon C. Park, AIA. September, 1984.

PTN 9 Windows(9): Interior Storm Windows: Magnetic Seal by Charles E. Fisher. September, 1984.

PTN 10 Temporary Protection(1): Temporary Protection of Historic Stairways During Rehabilitation Work by Charles E. Fisher. March, 1985.

PTN 11 Windows(10): Temporary Window Vents in Unoccupied Historic Buildings by Charles E. Fisher and Thomas A. Vitanza. August, 1985.

PTN 12 Windows(11): Installing Insulating Glass in Existing Wooden Sash Incorporating the Historic Glass by Charles E. Fisher. September, 1985.

PTN 13: Not issued.

PTN 14 Museum Collections(1): Museum Collection Storage in a Historic Building Using a Prefabricated Structure by Don Cumberland, Jr.. September, 1985.

PTN 15 Windows(13): Aluminum Replacement Windows with Sealed Insulating Glass and Trapezoidal Muntin Grids by Charles Parrott. September, 1985.

PTN 16 Historic Interior Spaces(1): Preserving Historic Corridors in Open Office Plans by Christina Henry. October, 1985.

PTN 17 Exterior Woodwork(1): Proper Painting and Surface Preparation by Sharon C. Park, AIA. May, 1986.

PTN 18 Exterior Woodwork(2): Paint Removal from Wood Siding by Alan O'Bright. September, 1986.

PTN 19 Windows(14): Reinforcing Deteriorated Wooden Windows by Paul Stumes, P. Eng. November, 1986.

PTN 20 Windows(15): Interior Storms for Steel Casement Windows by Charles E. Fisher and Christina Henry. November, 1986.

PTN 21 Windows(16): Repairing and Upgrading Multi-Light Wooden Mill Windows by Christopher Closs. December, 1986.

PTN 22 Windows(12): Aluminum replacement for Steel Industrial Sash by Charles E. Fisher. December, 1986.

PTN 23 Masonry(1): Substitute Materials: Replacing Deteriorated Serpentine Stone with Pre-Cast Concrete by Robert M. Powers. September, 1988.

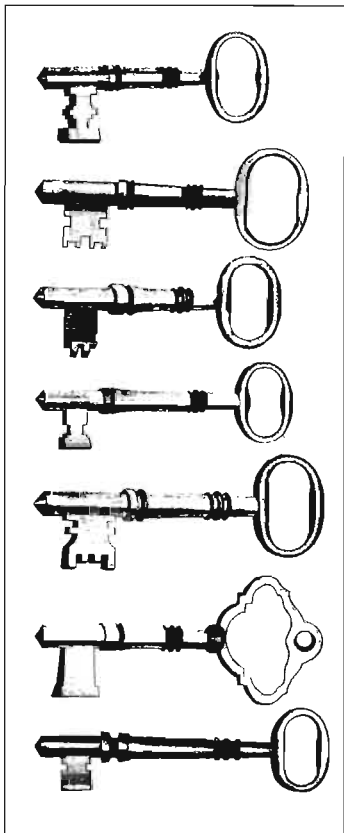
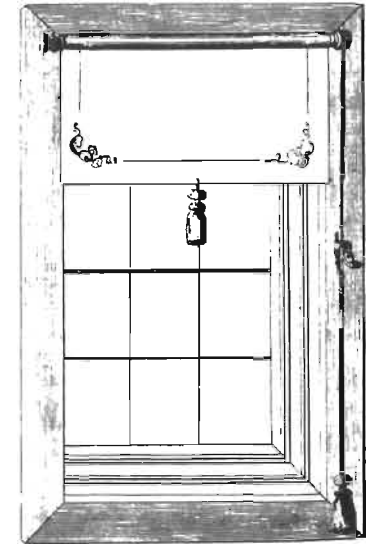



PTN 24 Mechanical Systems(1): Replicating Historic Elevator Enclosures by Marilyn E. Kaplan, AIA. June, 1989.

PTN 25 Doors(1): Historic Garage and Carriage Doors: Rehabilitation Solutions by Bonnie J. Halda, AIA. July, 1989.

PTN 26 Historic Interior Spaces(2): Preserving Historic Office Building Corridors by Thomas G. Keohan. July, 1989.

PTN 27 Metals(1): Conserving Outdoor Bronze Sculpture by Dennis R. Montagna. August, 1989.

PTN 28 Exterior Woodwork (3): Log Crown Repair and Selective Replacement Using Epoxy and Fiberglass Reinforcing Rods by Harrison Goodall. September, 1989.

PTN 29 Windows(17): Repair and Retrofitting Industrial Steel Windows by Robert M. Powers. August, 1989.

PTN 30 Museum Collection(2): Reducing Visible and Ultraviolet Light Damage to Interior Wood Finishes by Ron Sheets and Charles E. Fisher. September, 1990.

PTN 31 Finishes(1): Process Painting Decals as a Substitute for Hand-Stencilled Ceiling Medallions by Sharon C. Park, AIA. September, 1990.

PTN 32 Metals(2): Restoring Stamped Zinc and Galvanized Steel Roof Cornices by Richard Pieper. September, 1990.

PTN 33 Metals(3): In-kind Replacement of Historic Stamped-Metal Exterior Siding by Rebecca A. Shiffer. September, 1991.

PTN 34 Masonry(2): Stabilization and Repair of a Historic Terra Cotta Cornice by Jeffrey S. Levine and Donna Ann Harris. September, 1991.

PTN 35 Site(1): Restoring Vine Coverage to Historic Buildings by Karen E. Day. October, 1991.

PTN 36 Windows(19): Aluminum Replacement With True Divided Lights, Interior Piggyback Storms, and Exposed Historic Wooden Frames by Charles Parrott. October, 1991.

FLUSH RINGS

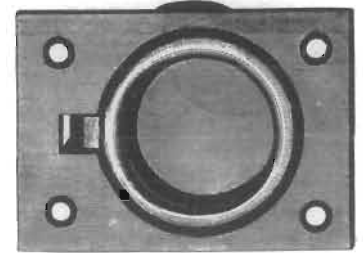

Flush Rings, for Sliding Barn and Trap Doors

Co-Published Books

Interiors Handbook for Historic Buildings. National Park Service and the Historic Preservation Education Foundation (HPEF). Charles E. Fisher, Ed. Prepared for a national conference on appropriate interior treatments for historic buildings, includes nearly 400 pages of technical papers as well as guidance for architects, developers, building managers, curators, and property owners. Addresses both rehabilitation and restoration issues, including inspection, evaluation and planning, architectural features and materials, systems and fixtures, space utilization and adaptive reuse, finishes and decorative accessories, and fire protection and building codes. 550 pages. Illustrated. 1988.

Respectful Rehabilitation: Answers to Your Questions on Historic Buildings. National Park Service and National Trust for Historic Preservation. Kay D. Weeks and Diane Maddex, Eds. Provides answers to 150 questions often asked in rehabilitating historic buildings for new uses. 185 pages. 150 illustrations. Bibliography. 1982.

The Window Handbook: Successful Strategies for Rehabilitating Windows in Historic Buildings. National Park Service and the Center for Architectural Conservation, Georgia Institute of Technology. Charles E. Fisher, Ed. 16 Preservation Tech Notes on windows. 262 pages. Illustrated. Appendices. 1986.

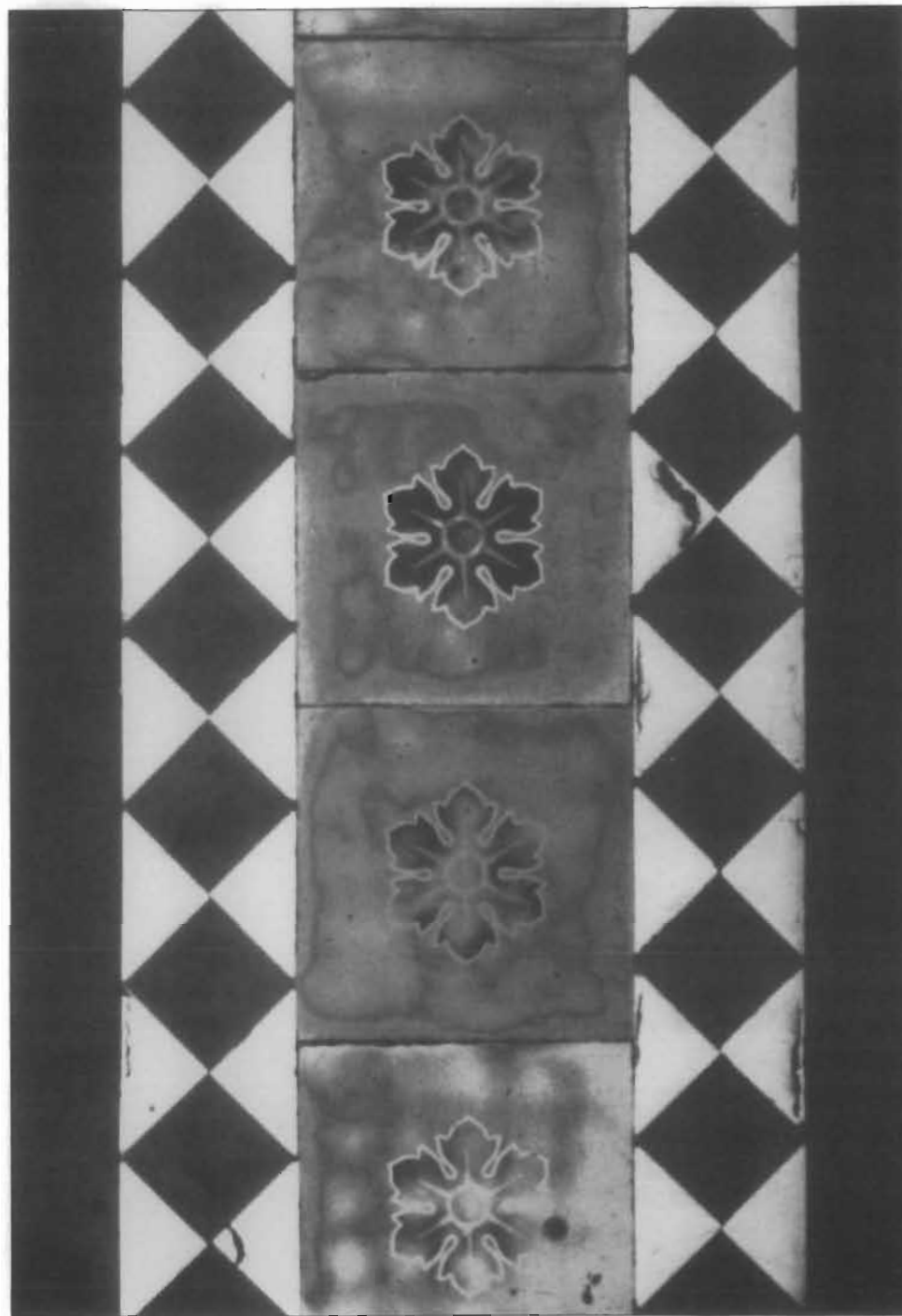

ISBN 0-16-035979-1



9 780160 359798



90000



"The many awards garnered by historic rehabilitation projects throughout the Nation are testimony to the value of the Secretary's Standards and Guidelines."

*Nellie Longworth
President
Preservation Action*